

# ENGLISH FOR TODAY

## Class-Eight



NATIONAL CURRICULUM AND TEXTBOOK BOARD, BANGLADESH

Prescribed by the National Curriculum and Textbook Board  
as a Textbook for Class Eight from the academic year 2013

---

# **ENGLISH FOR TODAY**

## **Class Eight**

Writers

M S Hoque

Yasmin Banu

Surajit Roy Majumder

Md Abdur Razzaque

Naina Shahzadi

Nargis Akhter Banu

Editor

Abdus Subhan

**Published by**  
**National Curriculum and Textbook Board**  
**69-70, Motijheel Commercial Area, Dhaka**

---

**[All rights reserved by the Publisher]**

First Publication : September, 2012  
Revised Edition : September, 2014  
Reprint : , 2019

**Design**  
**National Curriculum and Textbook Board**

For Free Distribution by the Government of the People's Republic of Bangladesh

---

**Printed by :**

## **Preface**

The aim of secondary education is to make the learners fit for entry into higher education by flourishing their latent talents and prospects with a view to building the nation with the spirit of the Language Movement and the Liberation War. To make the learners skilled and competent citizens of the country based on the economic, social, cultural and environmental settings is also an important issue of secondary education.

The textbooks of secondary level have been written and compiled according to the revised curriculum 2012 in accordance with the aims and objectives of National Education Policy-2010. Contents and presentations of the textbooks have been selected according to the moral and humanistic values of Bengali tradition and culture and the spirit of Liberation War 1971 ensuring equal dignity for all irrespective of caste and creed of different religions and sex.

The present government is committed to ensure the successful implementation of Vision 2021. Honorable Prime Minister, Government of the People's Republic of Bangladesh, Sheikh Hasina expressed her firm determination to make the country free from illiteracy and instructed the concerned authority to give free textbooks to every student of the country. National Curriculum and Textbook Board started to distribute textbooks free of cost since 2010 according to her instruction.

In the era of globalization, English is one of the most powerful tools for pursuing higher studies, using technology, intercultural and inter-personal communications, and job markets at home and abroad. The curriculum makes it explicit that language learning will be graded and contents will reflect real life situations as the ultimate purpose of language learning is to communicate. The English for Today textbooks have been developed to help students attain competency in all four language skills, i.e. listening, speaking, reading and writing. The contents and illustrations of this textbook have been developed in order to suit the learners' age and cognitive level.

I thank sincerely all for their intellectual labor who were involved in the process of revision, writing, editing, art and design of the textbook.

**Professor Narayan Chandra Saha**

Chairman

National Curriculum and Textbook Board, Bangladesh

## Contents

<b>Unit</b>	<b>Title</b>	<b>Page</b>
Unit 1	A glimpse of our culture	1-9
Unit 2	Food and nutrition	10-17
Unit 3	Health and hygiene	18-32
Unit 4	Check your reference	33-43
Unit 5	Making a difference	44-59
Unit 6	Going on a foreign trip	60-77
Unit 7	Different people, different occupations	78-87
Unit 8	News! News! News!	88-103
Unit 9	Things that have changed our life	104-124
	Sample Question	125-128

## Unit One

# A glimpse of our culture

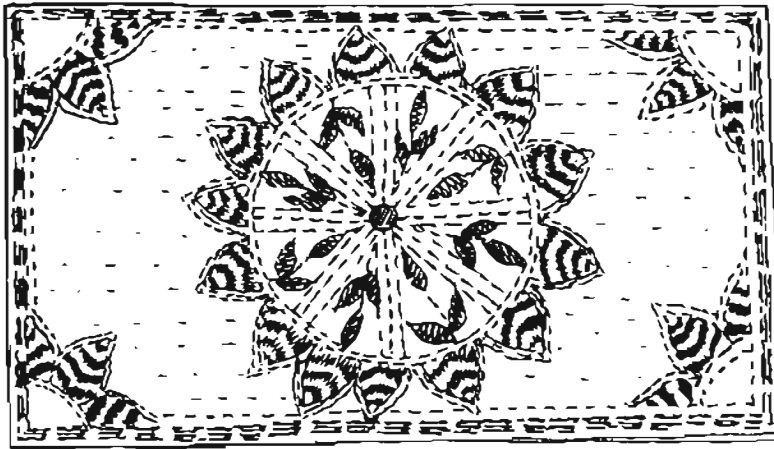
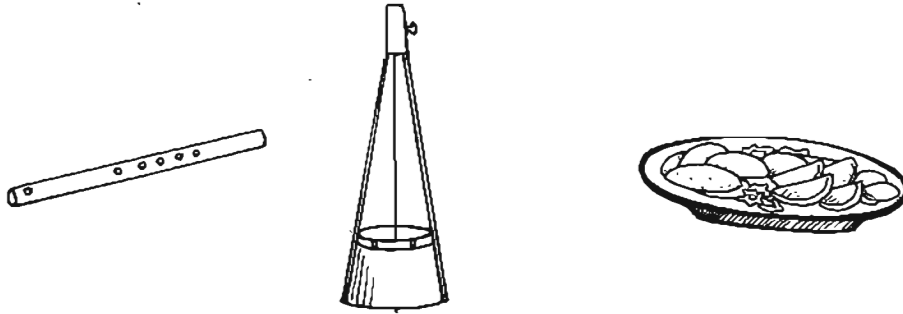

After we have studied this unit, we will be able to

- read and understand texts through silent reading
- infer meaning from context
- ask and answer questions
- write answers to questions
- write short compositions

## Lesson 1: Our folk songs

**Key words :** folk musical instruments

**A Work in pairs. Read out the musical instruments and answer the following questions.**

dotara	sarinda	guitar	bamboo flute	drum
tabla	piano	harmonium	ek-tara	violin

- 1 Can you sing a song?
- 2 Can you play any of these musical instruments?
- 3 Do you know anybody who can play any of these instruments? Tell what you know about her/him.

**B Read the text and answer the following questions.**

Folk songs are songs sung in the traditional style of a community or country. Here the traditional style includes the themes, words and tunes of the songs that have existed for a long time among the common people.

We have a rich history and collection of folk songs in Bangladesh. Of them *Palligiti, Bhatiali, Bhawaiya, Jari, Sari, Gambhira, Lalongiti, Palagaan* and songs of Hason Raja are very popular. The traditional musical instruments are usually played with these songs.

### Questions

- 1 Who usually likes our folk songs?
- 2 Can you name some well known folk singers?
- 3 Do you like folk songs? If you do, who is your favourite folk singer?  
Which song or songs do you like most?
- 4 Look at the musical instruments in **Activity A** above and say which instruments go well with the folk songs.
- 5 Discuss in groups whether the modern instruments like the guitar and the piano could be played with the folk songs.

- C Discuss in groups and write a paragraph on the following question.**  
Do you want more or less programmes on folk songs on our TV channels? Why?/Why not?

### **Lesson 2: Nakshi Kantha**

**Key words :** quilt artistic commercially traditional demand pattern

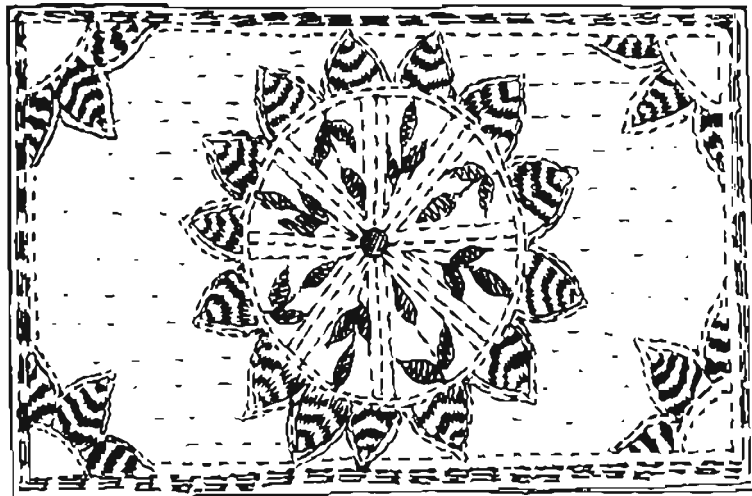

- A Look at the picture and the questions. Then ask and answer the questions with your partner.**

- 1 What do you see in the picture?
- 2 What is it called?
- 3 Have you seen it before? Where?
- 4 What do we do with it?

- B Now, read the text to know about nakshi kantha.**

*Nakshi kantha* is a kind of embroidered quilt. The name was taken from the Bengali word, '*naksha*' which means artistic pattern. It is a kind of traditional craft and is said to be indigenous to Bangladesh and West Bengal in India. The art has been practised in rural Bengal for centuries. The name '*Nakshi Kantha*' became popular after the poet Jasimuddin's poem '*Nakshi Kanthar Math*' was published in 1929.



Traditional *kanthas* are made for family use. Old or new cloth and thread are used to make these quilts. Mymensingh, Jamalpur, Rajshahi, Faridpur, Bogra and Jessore are most famous for this craft. Now it is produced commercially. You can find them in many expensive handicraft shops in cities. The quilts are now in great demand because of the colourful patterns and designs embroidered on them.

**C** Write a Paragraph describing how the *nakshi kantha* is made. Start like this:  
Old or new cloth and coloured thread are needed. First the cloth is folded, then.....

**D** Do you like a *nakshi kantha* or an ordinary *kantha*? Why?

**E** Complete the sentences with clues given

Bengali patterns embroidery years fashion art rural designs quilt *naksha*

- 1 *Naksha* means artistic .....
- 2 The name was taken from a ..... word .....
- 3 The art has been practised in ..... Bengal for .....
- 4 *Nakshi kanthas* are now sold in ..... shops.
- 5 *Nakshi kanthas* are in great demand because of their colourful ..... and .....
- 6 *Nakshi kanthas* are a kind of .....

**F** Write down five questions for the completed statements in activity E above.

One is done for you.

- 1 What does *naksha* mean ?

**G** Work in pairs. Ask and answer all the questions in activity. Now, write 3-4 more questions on the text given in activity B above.

**Lesson 3 : Our ethnic friends (1)****Key words :** ethnic region majority shifting**A Look at the question following and discuss in groups.**

Have you heard the word 'ethnic people'? Can you tell what it means?

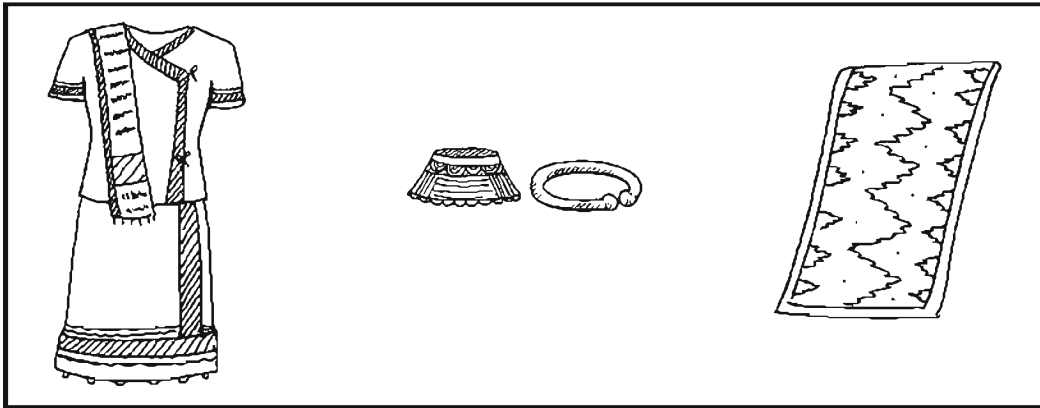
**Now, look at the pictures. Then discuss the following questions.**

- 1 Do you know where the ethnic people live in Bangladesh?
- 2 What are they called?

**B Now, read the text.**

The ethnic people in Bangladesh hold a very important place in the culture of the country. The majority of these people live in the Chittagong Hill Tracts. The others live in the regions of Mymensingh, Rajshahi and Sylhet. They live in forest areas, in the hills and in rural areas. They do *Jhum* cultivation. For this work they clear a piece of land in the forest, prepare it and sow seeds in it. They are mostly farmers. By religion they are Hindus, Christians or Buddhists. They speak their own mother tongues. Some of them are the *Chakmas*, the *Marmans*, the *Tipperas* and the *Moorangs*, who live in the Hill Tracts. The *Santals* live in Rajshahi. The *Khasias* and the *Montpuries*, live in Sylhet and the *Hajangs* and the *Garos* in Mymensingh.

**C True or false? If false, give the correct information.**

- 1 All the ethnic people of our country live in the Chittagong Hill Tracts.
- 2 Most of them are farmers.
- 3 By religion all of them are Buddhists.
- 4 The Moorangs are an ethnic group.
- 5 They practise *jhum* cultivation.

**D Ask and answer the questions in pairs.**

- 1 Where do you find the *Marmans*?
- 2 What language do they speak at home?
- 3 Where and how do they do the Jhum cultivation?

### Lesson 4: Our ethnic friends (2)

**Key words :** characteristics communities maize poultry

**A Look at the pictures and talk with your partner about them. Then read the text.**



Most of these ethnic people living in Bangladesh have some common characteristics. They have their own lifestyles.

They build their houses on bamboo or wooden platforms called '*machang*'. Rice is their staple food. They eat vegetables, maize and fish, poultry and meat. Their kitchen utensils are bamboo, wooden and earthen pots which they make themselves. Men wear *lungis* and women wear *thamis* or *sarongs* and *angis*. Women weave their own clothes.



Hunting and fishing are their favourite pastimes. They are fond of songs, music, dances, theatre and fairs. Traditional musical instruments used are bugles made from buffalo horns, drums and bamboo flutes. Wrestling is a popular sport for them.

**B Find the answers from column B to the questions in column A and write them in complete sentences.**

A	B
1. Where do the ethnic people build their houses?	a) traditional musical instrument made from a buffalo horn
2. What are their favorite pastimes?	b) clay, bamboo and wood
3. What is a bugle?	c) rice
4. What do the women wear?	d) on the wooden or bamboo platforms
5. What are their kitchen utensils made of?	e) fishing and hunting
6. What is their staple food?	f) <i>thamis</i> or <i>sarongs</i> and <i>angis</i>

**C Complete the paragraph. Use the words below to fill in the gaps. There are more words than necessary.**

*lungi* sport earthen *machang* weave wrestling song rice fishing lifestyles wooden bugle

The tribal people follow their \_\_\_\_\_.

The platform they build their houses on is called \_\_\_\_\_. Men wear \_\_\_\_\_. Women \_\_\_\_\_ their own clothes. Their staple food is \_\_\_\_\_. They are fond of songs, dance, music, and \_\_\_\_\_. \_\_\_\_\_ is their favourite sport.

**D Imagine you are Sajeed and you have a Marma friend called Masing. Now, write a dialogue asking and answering questions about dress,**

food, songs, sports and pastimes of both of you.

### Lesson 5 : Bangladeshi cuisine

**Key words** : cuisine platter molasses

**A Look at the pictures and discuss in pairs.**



- 1 What do you see in the pictures?
- 2 Which foods are seen in the pictures? Do you prepare/eat them at home?
- 3 Of the four foods, which one is your favourite? Why?

**B Read the text below and answer the following true-false Activity in section.**

Bangladeshi cuisine is rich and varied with the use of many spices. We have delicious and appetizing food, snacks and sweets.

Boiled rice is our staple food. It is served with a variety of vegetables, curry, lentil soups, fish and meat. Fish is the main source of protein. Fishes are now cultivated in ponds. Also we have fresh-water fishes in the lakes and rivers. More than 40 types of fishes are common. Some of them are *carp*, *ruji*, *katla*, *magur* (catfish), *chingri* (prawn or shrimp). *Shutki* or dried fishes are popular. *Hilsha* is very popular among the people of Bangladesh.

*Panta ilish* is a traditional platter of *Panta bhat*. It is steamed rice soaked in water and served with a fried *hilsha* slice, often together with dried fish, pickles, lentil soup, green chilies and onion. It is a popular dish on the *Pohela Boishakh*.

The people of Bangladesh are very fond of sweets. Almost all Bangladeshi women prepare some traditional sweets. *Pitha*, a type of sweets made from rice flour, sugar, syrup, molasses and sometimes milk, is a traditional food

loved by the entire population. During winter *Pitha Utsab*, meaning *pitha* festival, is organized by different groups of people.

Sweets are distributed among close relatives when there is good news like births, weddings, promotions, etc.

Sweets of Bangladesh are mostly milk-based. The common ones are *roshgolla*, *sandesh*, *rasamalai*, *gulap jamun*, *kalo jamun* and *chom-chom*. There are hundreds of different varieties of sweet preparations. Sweets are therefore an important part of the day-to-day life of Bangladeshi people.

**C True or false? If false, give the correct information.**

- 1 Our foods are rich because they have a lot of oil in them.
- 2 We get protein mostly from fish.
- 3 On *Pohela Boishakh*, the traditional food is steamed rice and fried *hilsha*.
- 4 *Pitha Uthsab* takes place almost all the year round in Bangladesh.
- 5 Sweets are not much appreciated by the people of Bangladesh.

**D Read the text in B again and answer the following questions.**

- 1 What has made Bangladeshi food so special?
- 2 Where do we get the fishes from?
- 3 Apart from fish, what other foods do we eat with rice?
- 4 Why are sweets an important part of our life?

**E Discuss and answer the questions in pairs.**

- 1 Describe a Bangladeshi food that you like best.
- 2 Make a list of the things you and your partner eat every day.
- 3 Make two lists of food one eaten by the urban and the other by the rural people.
- 4 Why are there differences between the food eaten by the urban and the food eaten by the rural people?

**F How fast can you say this sentence?**

Casual clothes are provisional for leisurely trips across Asia.

## Unit Two

# Food and nutrition

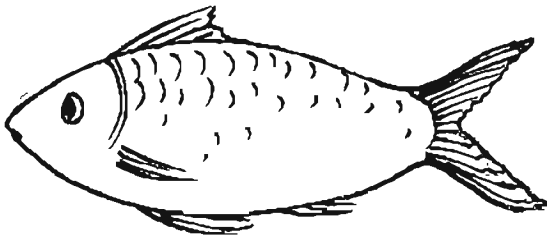
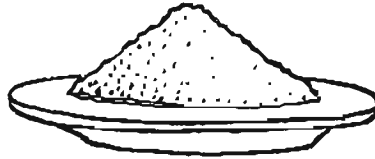
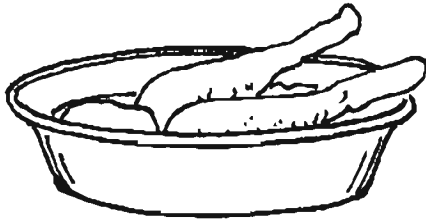

**After we have studied this unit, we will be able to**

- read and understand texts through silent reading
- listen for information
- ask and answer questions
- write answers to questions
- practise sounds

**Lesson 1: Good food**

**Key words :** nutritious substances physical structure

**A Talk about the picture and read the text.**

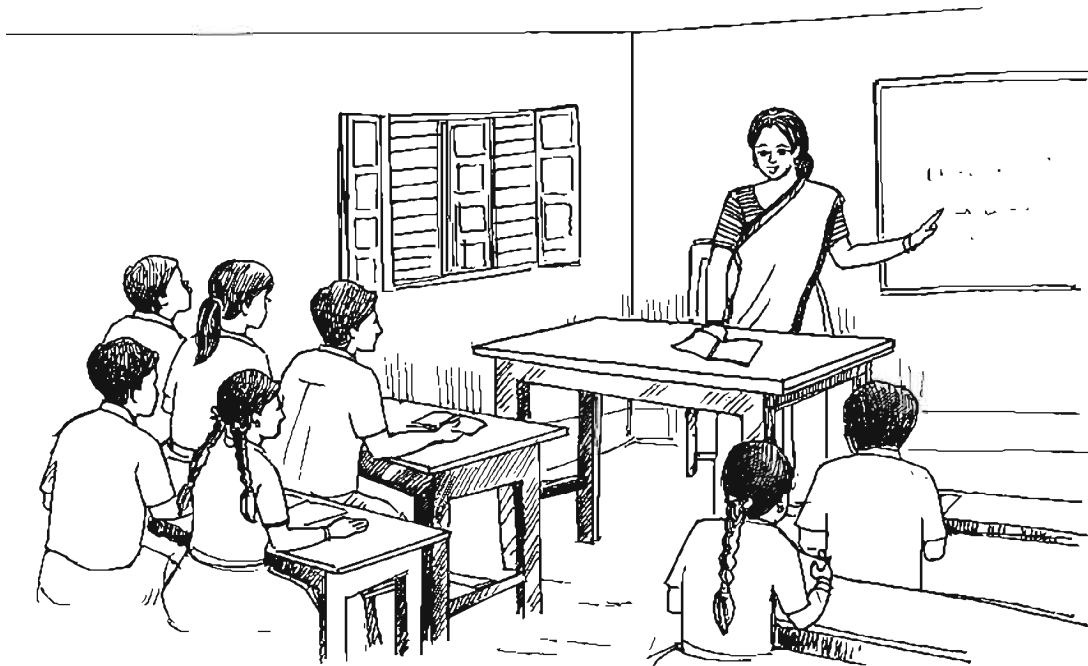

Ms Rehana, the English teacher, is talking to the class about food.

“Food is very important for our body,” she says. “We can’t live without it. So you must always have good food.”

“What’s good food, teacher?” asks a student.

“Good food means the right kind of food for good health,” says Ms Rehana. “It is nutritious. It must contain natural substances that our body needs to grow properly and stay healthy. But remember, you must not eat too much though the food is good. Eating too much is bad for health. You have to eat only a certain amount of food that your body needs. So we do not need the same kind of food in the same quantity. It depends on your growth and physical structure”.



**B Answer the following questions.**

- 1 What is Ms Rehana talking about?
- 2 Why do we eat food?
- 3 What is meant by 'nutritious food'?
- 4 How much food does a person need to eat a day?
- 5 Does everyone need the same amount of food? Why?

**C Complete these sentences.**

- 1 We should eat good food to \_\_\_\_\_.
- 2 We should not eat more than \_\_\_\_\_.
- 3 Eating too much food is not \_\_\_\_\_.
- 4 Good food means \_\_\_\_\_.

**Lesson 2: Kinds of food**

**Key words :** Carbohydrate Protein Vitamins Minerals

**A Listen to the teacher/CD and answer the following questions.**

U2, L2 A Listening text: 1
-------------------------------

**Questions**

- 1 How many kinds of food do we need?
- 2 What are they?

**Now, choose the best answer.**

**1 Foods are divided into classes according to their**

- a colours and tastes.
- b shapes and sizes.
- c substances they contain.
- d water they contain.

**2 Potatoes contain a lot of**

- a carbohydrate.
- b protein.
- c vitamins.
- d minerals.

**3 Butter and ghee are a good source of**

- a protein.
- b fat.
- c vitamins.
- d carbohydrate.

**4 Minerals are present in**

- a nuts.
- b peas.
- c milk.
- d water.

**5 Which food has the most carbohydrate?**

- a sugar
- b rice
- c fruits
- d vegetables

**Lesson 3: Our daily diet**

**Key words:** essential disease calcium interval

**A Read the dialogue.**

Ms Rehana : Let's talk about some essential foods that we need to eat regularly.

For our good health we must choose the right food in our daily diet.

Student 1 : We eat rice, 'ruti', fish and meat every day. What else should we have, teacher?

Ms Rehana : Well, we must also eat vegetables and fruits. They contain a lot of vitamins and minerals. They keep our body free from diseases. They are also good for our skin and overall health.

Student 2 : Should we have anything else?

Ms Rehana : Sure. We need to drink milk every day. Milk is highly rich in calcium. It's good for our healthy growth. It makes our bones and teeth strong as well. We must drink pure water at regular intervals too. It's essential for our body. We can't live without drinking water.

**B Make five questions from the following table.**

Why	do	essential for our body? good for our skin?
What	are	we need to eat good food?
What foods	is	vegetables contain? minerals do to us?

**C Now, write the answers to the questions that you have made in section B.**

**D Read the text in section A again and tick the best answer.**

- 1 Milk is highly rich in fat/calcium/sugar.
- 2 Fruits and vegetables are good for eyes/ general health/ teeth.
- 3 Water/energy drink/milk is most important for life.

## Lesson 4: A delicious dish

**Key words :** custard peel

**A Look at the pictures. What do you see?**



**B Ask and answer the questions.**

- 1 What type of food do you like?
- 2 Why do you like these?
- 3 Where do you get these from?
- 4 Do you eat home-made food?

**C Look at the picture. What do you see in the picture?**

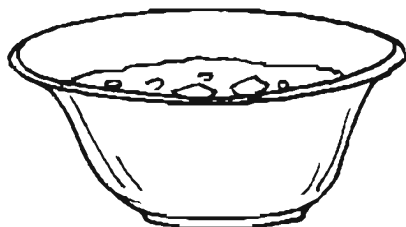

**Now, read the following recipe.**

### **Ingredients:**

- 1 Ripe banana: 1
- 2 Apple: 1
- 3 Ripe papaya: 1 (small)
- 4 Custard powder: 2 tablespoons
- 5 Milk: half litre
- 6 Sugar: 4 tablespoons

**How to prepare**

First wash the fruits and peel them. Then cut the fruits into small pieces and keep them in a bowl. Now boil the milk in a pot. Next mix sugar with it and stir well. Take the custard powder in a small cup, put 4 tablespoons of cold milk and mix well. Now pour the mixture into the boiling milk and stir well. Boil for five minutes, stirring it all the time. After that, take the pot off the stove. Let the custard cool. Finally pour it into the fruit bowl. Now, the delicious custard is ready to eat.

**D Describe how to make a cup of tea, using the following sentence connectors.**

First	Then	Next	After that	Finally
-------	------	------	------------	---------

**Lesson 5: A little plant**

**Key words :** bury creep

**A Talk about the pictures.**

**Then read and listen to the poem.**

**A little plant**

In the heart of a seed  
 Buried deep, so deep,  
 A dear little plant  
 Lay fast asleep.  
 "Wake!" said the voice  
 Of the rain drops bright.  
 The little plant heard.  
 And rose to see  
 What the wonderful  
 Outside world might be.

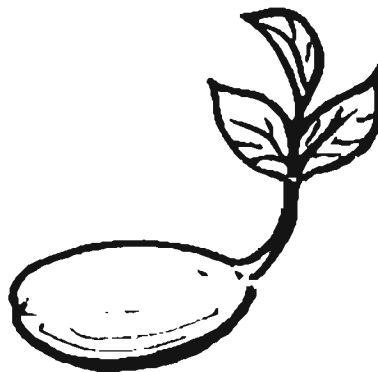

**B As you listen to the poem, notice how these groups of words are pronounced. Practise saying these words.**

- 1 seed, deep, asleep, see
- 2 heard, world
- 3 lay, wake, rain

**C Ask and answer the questions.**

- 1 Where is the little plant sleeping ?
- 2 Who spoke to the little plant ?
- 3 What did they want the little plant to do?
- 4 What two things do plants need in order to grow ?
- 5 Which word in the poem means “grow” ?

## Unit Three

# Health and hygiene

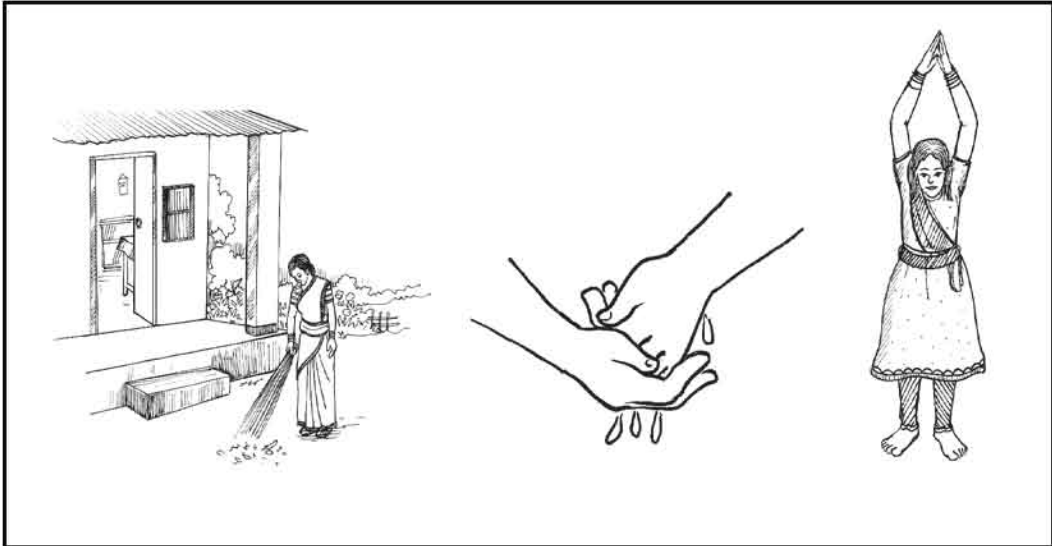

**After we have studied this unit, we will be able to**

- read and understand texts through silent reading
- listen for information
- ask and answer questions
- write the answers to questions
- practise sounds
- write paragraphs/ compositions

**Lesson 1: Health**

**Key words :** disease essential concentrate possession

**A Look at and talk about the picture. Ask and answer the following questions.**

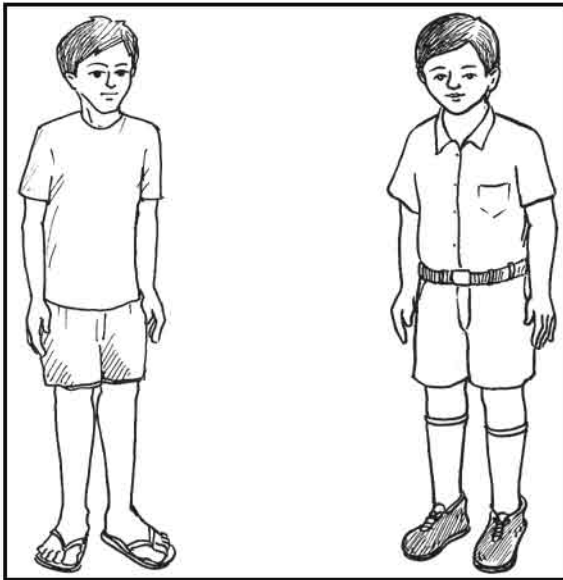

- 1 Which boy looks healthy?
- 2 Which boy is unhealthy?
- 3 Can you guess why they are so?

**B Read the questions first. Then read the text and answer the questions.**

- 1 Why is good health essential for us?
- 2 Why is physical exercise necessary?

Health is the condition of our body and mind. It may be good or bad. Good health means healthy body free from diseases. It is essential for everyone to lead a happy life. If we are not in good health, we cannot concentrate on any activity in our life.

A proverb goes, “Health is Wealth” It means health is equally valuable as gold or any other personal possessions. We may have vast wealth and property, but if we are not healthy we cannot enjoy them.



To keep ourselves healthy, we have to do certain things. We have to take a balanced diet. We must exercise regularly to keep our body fit for work. There is an old saying : 'Early to bed and early to rise

Makes a man healthy, wealthy and wise.'

So, we should not keep late hours. We should go to bed early at night and rise early in the morning. Peace of mind is another condition for good health. So we must not worry over small things of life.

**C Read the text in B silently and then choose the best answer.**

- 1 Health means the condition of
  - a our body.
  - b our mind.
  - c our body and mind.
  - d our environment.
  
- 2 A healthy person is one who
  - a is physically and mentally sound.
  - b eats good food.
  - c has a lot of wealth.
  - d is overweight.
  
- 3 We need to eat
  - a rich food.
  - b balanced food.
  - c little food.
  - d lot of food.
  
- 4 The phrase 'to keep late hours' means
  - a to go to bed late.
  - b to wake up late in the morning.
  - c to do things late always.
  - d to be late for the class.

**D Write a short paragraph about how you can maintain good health.**

**Lesson 2: Ode on Solitude**

A Read and recite the poem.

**Ode on Solitude**

Happy the man, whose wish and care  
A few paternal acres bound,  
Content to breathe his native air,  
In his own ground.  
Whose herds with milk, whose fields with bread,  
Whose flocks supply him with attire,  
Whose trees in summer yield him shade,  
In winter fire.

Blest! who can unconcern'dly find  
Hours, days and years slide soft away,  
In health of body, peace of mind,  
Quiet by day,

Sound sleep by night; study and ease  
Together mix'd; sweet recreation,  
And innocence, which most does please,  
With meditation.

Thus let me live, unseen, unknown;  
Thus unlamented let me die;  
Steal from the world, and not a stone  
Tell where I lie.

*Alexander Pope*

**B Answer the questions.**

- 1 What things does a happy man have?
- 2 How does he pass his time?
- 3 How does he wish to die?
- 4 How do you think you can be happy in life?

**Lesson 3 : Hygiene**

**Key words :** hygiene godliness achieve spiritually soul

A Read the questions first. Then read the text and answer them in short. Questions

- 1 What can be a hotbed of germs?
- 2 How many times should we brush our teeth a day?
- 3 What kind of water should we drink?

The word 'hygiene' means the practice of keeping ourselves clean. It also means to keep our home and work places clean. It is important for our good health.

Hygiene is thought to be next to godliness. It is because we cannot achieve anything physically, mentally or spiritually if we are unclean in our body, mind and soul. Nobody likes an unclean person either. So we must follow the rules of hygiene.

First, we must keep our body clean. We should have a bath every day and wash our hair regularly. This will keep the body and hair free from dirt and bacteria.

Secondly, we should wash our clothes regularly. Dirty clothes give off bad smell and invite germs. We should wear socks and shoes when we go out to protect our feet from dust and germs. It is also important to wash our hands before meals and after using the toilet. We should brush our teeth twice a day, after breakfast and supper. We must also cut our nails regularly. Our drinking water must be safe. We can get safe water by boiling and filtering.

Finally, we should keep our surroundings and environment clean.

If we do and follow all the above things properly, we will be able to lead a healthy and happy life.

**B True or false? If false, give the correct information.**

- 1 Cleanliness is part of good health.
- 2 Cleanliness is very important for mental health.
- 3 We need to wear socks and shoes to look smart.
- 4 We need to brush our teeth before meals.
- 5 We must keep ourselves clean.
- 6 We can have pure drinking water from tube wells.

**C Complete the following sentences.**

- 1 If we are healthy, we ----- .
- 2 We must be clean so that----- .
- 3 You must exercise to ----- .
- 4 Nobody likes an ----- .
- 5 If we obey the laws of hygiene, we ----- .

**Lesson 4 : A dialogue**

**Key word : prescribe**

**D Work in groups. Make a list of five things that you do daily to maintain personal hygiene. Share with other groups, make a poster and display it in the class.**

**A Talk about the picture and answer the questions.**

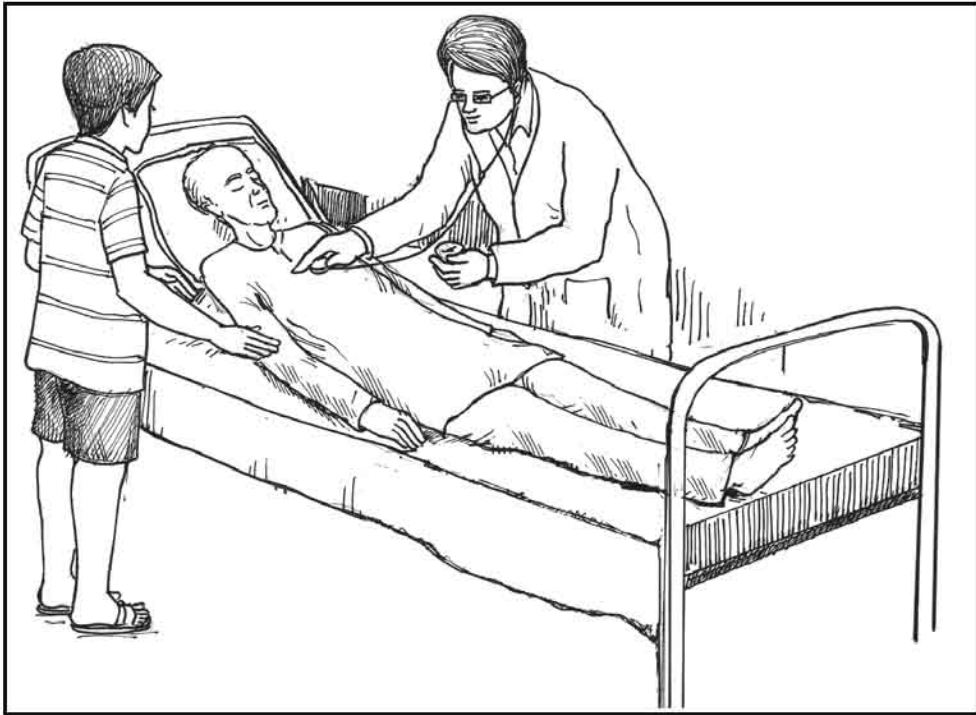

- 1 Who is the man lying on the examination table?
- 2 Who is the man in an apron?

**B Read and act out the conversation.**

Rabi's father Mr Zahir Ali is not well. He has difficulty speaking. He is now at the doctor's clinic.

Rabi : Good evening, doctor.

Doctor : Good evening. How is your father today?

Rabi : Not at all well. He has difficulty breathing as before. He is having severe chest pain again.

Doctor : I see. Mr Ali, could you lie down on the examination table, please? OK, let's see... Do you feel any pain here?

Zahir : Ooh!

Doctor : And here?

Zahir : Ouch!

Doctor : All right. I'm prescribing a medicine. Take one tablet in the morning and another at night before meals. I also advise you to have a chest X-ray immediately. If possible show me the X-ray report today in the evening. OK?

Rabi : Okay, doctor. Thank you.

Doctor : You are welcome.

**C Answer the following questions.**

- 1 Who are talking in the dialogue?
- 2 Where does the dialogue take place?
- 3 What are Zahir Ali's problems?
- 4 Why can't Zahir Ali tell the doctor about his problems?
- 5 What does the doctor prescribe him?

**D Ask and answer the questions in pairs.**

- 1 Did you have any stomach pain or leg injury anytime before?
- 2 When was it?
- 3 What did you do to get well?

E Suppose you visited a doctor for a stomach pain or bad cold. Make an imaginary dialogue between you and the doctor. Act it out in pairs.

**Lesson 5 : A letter****Key words :** nicotine tragedy broke puff**A Read the letter silently to know what happened to Zahir Ali.**

10/E Purana Paltan

Dhaka 1000

9 June 2013

Dear Sohel

I am sorry I could not reply to your letter earlier. This is because last week there was a tragedy in our family. My father died of lung cancer.

He used to smoke heavily. He got the bad habit from his college days. Recently my mother and I were very worried about Father's worsening health condition. He was having continuous chest pain. The doctor showed him his chest X-ray plates. There were dark marks on his lungs. The doctor explained to him that the marks were the signs of lung cancer. He also explained that a poisonous substance called nicotine is in tobacco leaves; and cigarettes are made from tobacco leaves. When a person smokes cigarettes, this nicotine enters into his lungs with every puff. If anybody smokes cigarettes for years, this deadly nicotine causes lung cancer. Both Mother and I tried to stop Father from smoking. He never listened to our requests and warnings. He died an untimely death.

Let me tell you the truth. My father's death is a great shock for us. You know, we are a big family of seven. My father was the only earning member in the family. We are now broke and we don't know how we are going to survive.

Anyway, God is merciful and we are trying to recover from the shock. Write me when you have the time. Give my regards to your parents.

Love

Rabi

**B Tick the best answer.****1 "My father's death is a great tragedy."**

The underlined word means

- a a very sad event.
- b a very strong warning.
- c smoking heavily.
- d lung cancer.

2 Rabi's family is now completely broke, because

- a his father had lung cancer.
- b they have now no source of income.
- c his father's death was heart breaking.
- d there was a tragedy in the family.

C Answer the questions. First say, then write.

- 1 What could be the relationship between the sender and the receiver of the letter?
- 2 What causes lung cancer?
- 3 Who do you think are the members of Rabi's family? Why do you think so?
- 4 Imagine you are Sohel. Now write a reply to Rabi's letter.

### Lesson 6 : Physical exercise

Key words : stretching benefit regularity

A Look at the picture and talk about it with your partner.

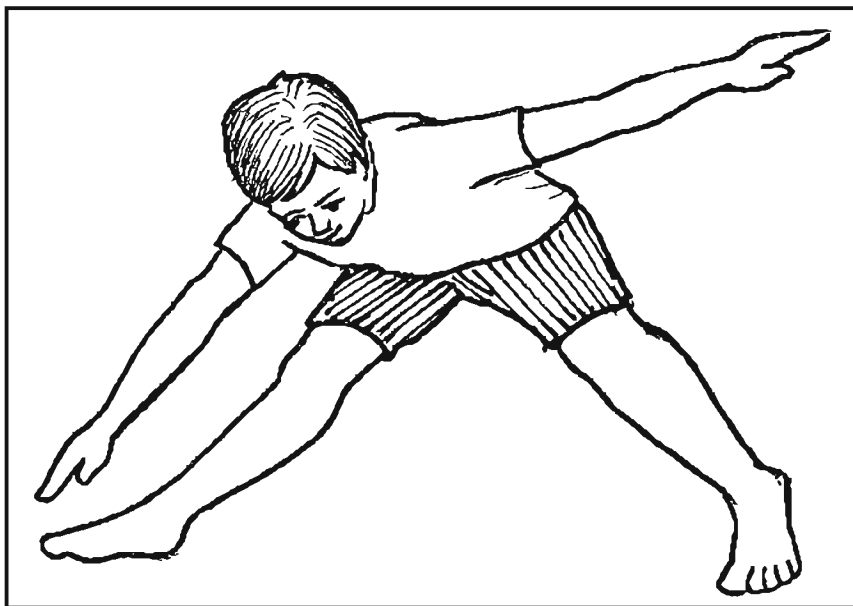

B Read the text and answer the following questions.

Mr Pronay Larma, the physical teacher of Rooppur High School is talking about health to his students.



"What things are necessary for good health?" he asks the students.

"We need a lot of things, teacher," says Rushad. "We need healthy food, proper rest and sleep. We also have to be clean and tidy."

"Good!" says Mr Larma. "These are the things you need for good health. But another thing that you also need is regular physical exercise."

"What types of physical exercise can we do, teacher?" asks Rayeed.

"Well," says Mr Larma. "There are different kinds of physical exercise. You can do them indoors as well as outdoors. In the house you can do some freehand exercises. That is, you can stretch different parts of your body. Outside, you can play, swim or simply walk."

"Why do we need physical exercise, teacher?" asks Ranjan.

"Well", says Mr Larma, "The benefits of physical exercise are many. The greatest of them is that it keeps you fit for work. It also gives you energy, and makes you strong and cheerful. It teaches you regularity and discipline as well."

### Questions

- 1 What things are necessary for good health?
- 2 How many physical exercises are there?
- 3 Why do we need physical exercise?
- 4 What physical exercises do you do?
- 5 Do you have a physical education teacher in your school? How does s/he help you to do physical exercise?

**C** Here Is a list of some physical exercises. Tick which one/ones you like. Then tell the class the reason/s for your liking. Finally write in your notebook which ones are indoor exercises and which are outdoors, and which ones can be done both indoors and outdoors.

#### List of exercises

- 1 playing sports
- 2 swimming
- 3 skipping
- 4 jogging
- 5 walking
- 6 stretching

**D Ask and answer the questions.**

- 1 Why do you need regular physical exercise?
- 2 What does physical exercise teach you?
- 3 Do you do physical exercise every day? What sort of exercise do you do?
- 4 What's your favourite sport? Do you take part in it? If so, where do you play it and who with?

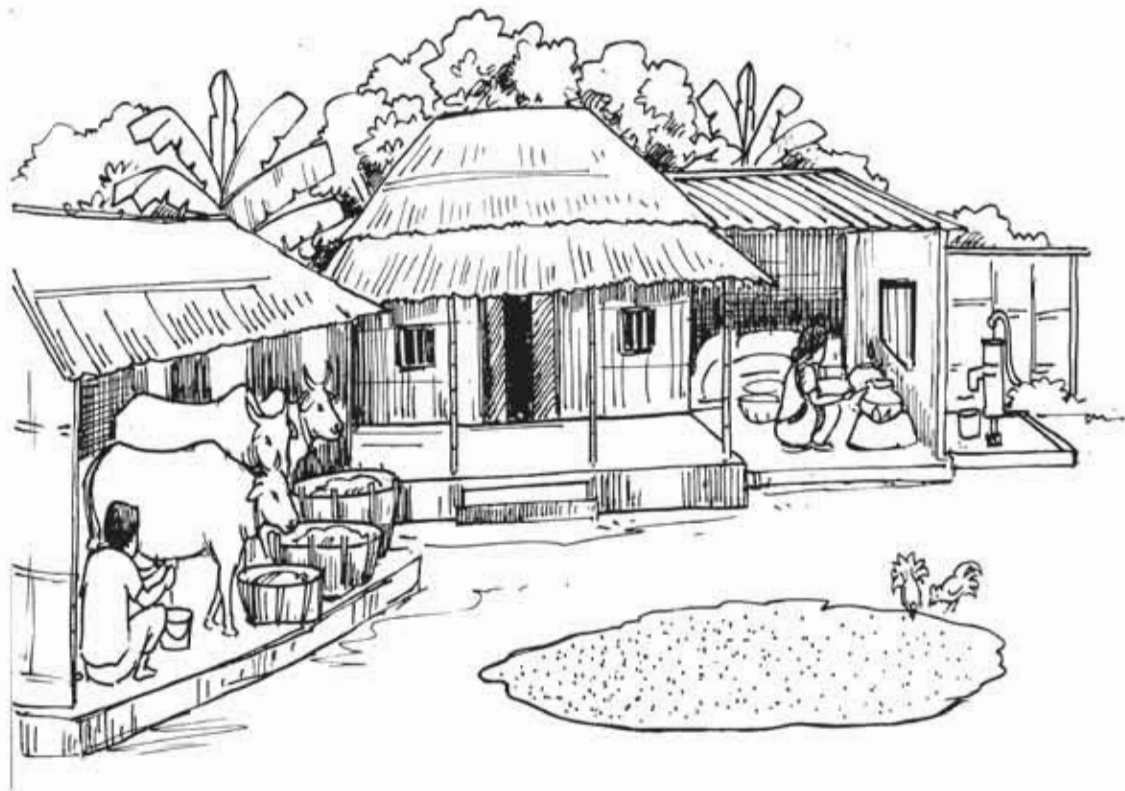
**Lesson 7 : A healthy and happy family****A Look at the picture. Then ask and answer the questions about it.**

- 1 What do you see in the picture?
- 2 Who do you think is the owner of the house?
- 3 Where can you find this type of house? Why do you think so?

**B Listen to the teacher/CD and answer the following questions.****U3, L7 B Listening text: 2**

- 1 How far is Shakib's house from his school?
- 2 Why is Shakib's house free from mosquitoes?

**C Listen again and write 'True' or 'False' against each of the following statements.**

- 1 Shakib's family lives in a remote town.
- 2 He has no brothers or sisters.
- 3 His parents do not know how to read or write.
- 4 His mother is an excellent cook.
- 5 Shakib does not participate in cleaning activities at home.

D Look at the table, then listen again to the teacher / CD. The table has some words from the text that you have just listened. First guess the meanings of the words. Then match them with their meanings. One is done for you.

Words	Meanings
remote	knowing about something
literate	about a disease that spreads from one person to another
delicious	isolated
aware	that causes harm to your health
harmful	having a very pleasant taste
contagious	able to read or write.

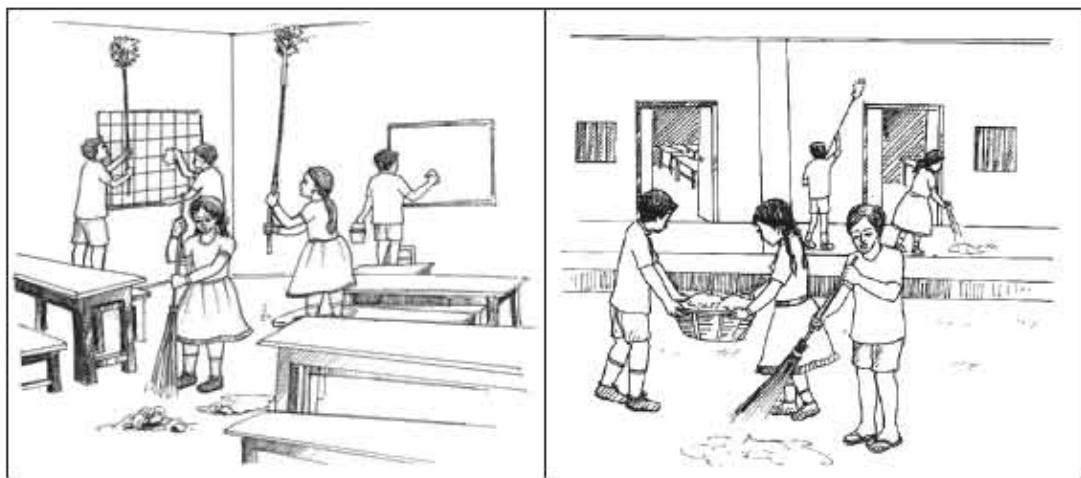
**Lesson 8 : Making a class committee****Key words :** forum environment fortnightly**A Look at the two pictures. Then ask and answer questions.**

Picture 1

Picture 2

- 1 What do you see in the picture ?
- 2 What are the students doing in picture 1 ?
- 3 What are they doing in picture 2 ?
- 4 Do you do these things at home? If you don't, who does ?

**B Read the passage and answer the following questions.**

Ms Subarna Saha, the class teacher, has just entered the classroom. She is now talking to the students.

"Why is the classroom so dirty?" asks Ms Saha. "I know the school cleaner is absent today. So what? Can't we ourselves keep our classroom clean?" says Ms Saha. "Sorry teacher," Shafiq, the class captain, says politely. "This is our classroom. If you clean it, you will do physical work and feel good. Also it is our responsibility to keep it clean and tidy", says Ms Saha.

"Okay, teacher," says Shafiq. "We'll do it from now on."

"First, you can make a forum, and select a leader," the class teacher suggests.

"Then divide the cleaning activities among different groups."

"It's really a great idea, teacher," says Shafiq. "We'll make the committee now and start working immediately."

After this, a committee is formed by class 8 students under the leadership of their class captain. The students are divided into several groups and a work plan is made for cleaning. The students decided to make some ground rules. Here is a list of some of the rules:

- Do not spit in the class.
- Do not drop litter in the class.
- Use the bin for trash.
- Keep the desks and chairs in place.

All the students of class 8 are very excited to be involved in this activity at school.

**C Choose the best answer.**

- 1 Ms Subarna Saha is
  - a a physical education teacher.
  - b an English teacher.
  - c a class teacher.
  - d a science teacher.
- 2 The class teacher suggested the students to make a forum
  - a to keep their classroom clean.
  - b to participate in social activities.
  - c to keep the school environment clean.
  - d to help each other.
- 3 The students were happy to be able to
  - a become the members of the committee.
  - b take part in the cleaning programme at school.
  - c make their class captain leader of the committee.
  - d make themselves good students.

## Unit Four

# Check your reference

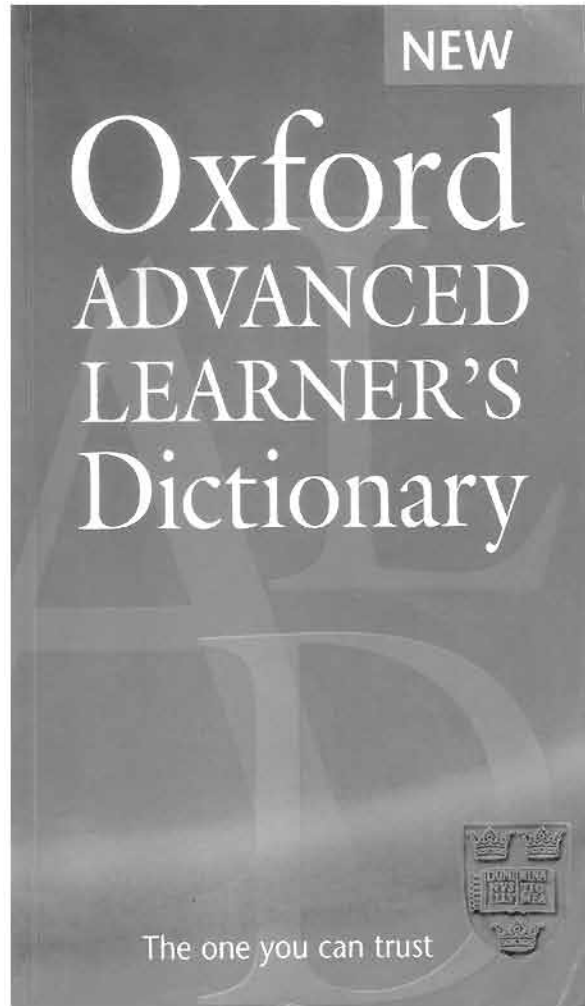

### Learning outcomes

After we have studied this unit, we will be able to

- read and understand content pages in books
- look up words in a dictionary

## Lesson 1: Introducing a table of contents

### A Look at the table and talk about it in groups.

## Contents

<b>To the Instructor</b>	<i>vii</i>
<b>To the Student</b>	<i>xiii</i>
<b>Acknowledgments</b>	<i>xv</i>

### Unit 1 *Animals*



1. The Kiwi	3
2. The Camel	6
3. The Polar Bear	11
4. The Hippopotamus	16
5. The Dolphin	21
Word Study	26
Extension Activities	29
• <b>ON</b> Video Activity: Dolphins in Honduras	29
• Activity Page	31
• Dictionary Page	32

### Unit 2 *How? Why?*



Context Clues	34
1. Why Are Elevators Important?	36
2. Why Is the Sea Salty?	41
3. How Can a Plant Kill?	46
4. How Can We Have Farms in the Sea?	52
5. How Do Hearing-Impaired People Talk?	57
Word Study	62
Extension Activities	65
• <b>ON</b> Video Activity: A New Kind of Tourism in Brazil	65
• Activity Page	67
• Dictionary Page	68

### Unit 3 *Plants*



Context Clues	70
1. The Date Palm	72
2. The Water Hyacinth	77
3. Rice	82
4. Oranges	87

*iii*

### B Now answer the questions below.

- 1 Is the table familiar to you?
- 2 Where do you find it?
- 3 What is the table about?
- 4 What is this table called?

**C Read the text and discuss in groups. Then try to find answers to the following questions.**

You get a new book in hand. You see the title of the book and you want to read it. But does the title only give you enough information about what the book is all about?

You also find the book divided into a few parts. Suppose you want to read a certain part of the book. Certainly you will not like to waste time looking for it in the whole book.

- 1 How do you know which page to look for it? What do you do?
- 2 Do you think the table in A can help you? How?

**D Look at the table of contents in Section A. Then ask and answer the questions below.**

- 1 What are the topics at page numbers vii, xiii, xv ?
- 2 If you want to read about the Hippopotamus, what unit and page numbers should you go to ?
- 3 What is the content at page number 65 ?
- 4 What page does the unit 2 start at and where does it end ?
- 5 Which topics appear between pages 26 –28?

**Lesson 2: Using a table of contents****A Look at the questions and discuss in small groups.**

- 1 Why do we need a table of contents to read a book?
- 2 What does a table of contents contain?

**B Now, read the text and ask and answer the questions following it.**

A table of contents is an important part of a book. It gives us information about what is inside a book. It tells us what each of the parts of the book is about. It also tells us how to go to the page where the part starts. A table of contents is usually written as 'contents' at the top of the page. The list of the parts is presented in the order that they appear in the book. The list contains the titles or the names of the parts. It sometimes mentions the sections as well as the subsection titles with the chapter/ unit/lesson titles.

It also includes the foreword or preface, book map, index, and the page numbers.



**C Ask and answer the questions.**

- 1 Why do we need a table of contents in a book?
- 2 In what order are the parts of a table of contents presented, e.g. lesson numbers?

**D True or false? If false, give the correct information.**

- 1 A table of contents gives us information only about the contents of a book.
- 2 A table of content contains some columns.
- 3 There is no link between the order of the list and that of the parts appearing in the book.
- 4 A chapter or unit title is sometimes followed by the section or subsection titles.

**E Open your English textbook. Find the table of contents page.****Look at the questions. Work in pairs and find out.**

- 1 What is the title of the page?
- 2 What are the column heads?
- 3 Which page numbers contain the topics?
- 4 Which topic starts in page 44?
- 5 How many units are there?
- 6 How many page numbers are there in the book?

**F Now give information about the following.**

Name/title of the table of contents page:

Names of column heads:

Numbers of units:

Total number of pages:

Title of the first unit:

Page number where the first unit starts:

Title of the last unit:

Position of the page numbers:

Position of the chapter titles:

Others, if any:

## Lesson 3 : Using a dictionary (1)

## A Look at the questions and the text and talk about them in groups.

- 1 Have you come across this type of text before?
- 2 Do you know what the text is about?
- 3 What do you know about a dictionary?
- 4 What do you find in a dictionary?

**fit** 0- w /fɪt/ verb, adj., noun

■ **verb** (fit-ting, fit-ted, fit-ted) (NAME usually fit-ting, fit, fit except in the passive)

- **RIGHT SIZE/TYPE** 1 (not used in the progressive tenses) to be the right shape and size for sb/sth: [V] *I tried the dress on but it didn't fit.* ◦ *That jacket fits well.* ◦ *a close-fitting dress* ◦ [VN] *I can't find clothes to fit me.* ◦ *The key doesn't fit the lock.* 2 [V, usually + adv./prep.] to be of the right size, type or number to go somewhere: *I'd like to have a desk in the room but it won't fit.* ◦ *All the kids will fit in the back of the car.* 3 [VN] (often passive) ~ sb (for sth) to put clothes on sb and make them the right size and shape:
- **PUT STH SOMEWHERE** 4 [VN] to put or fix sth some: *They fitted a smoke alarm to the ceiling.* ◦ *The rooms were all fitted with smoke alarms.* 5 (+adv./prep.) to put or join sth in the right place: [V] *The glass fits on top of the jug to form a lid.* ◦ *How do these two parts fit together?* ◦ [VN] *We fitted together the pieces of the puzzle.*
- **AGREE/MATCH** 6 (not used in the progressive tenses) to agree with, match or be suitable for sth; to make sth do this: [V] *Something doesn't quite fit here.* ◦ *His pictures don't fit into any category.* ◦ [VN] *The facts certainly fit your theory.* ◦ *The punishment ought to fit the crime.* ◦ *We should fit the punishment to the crime.*
- **MAKE SUITABLE** 7 ~ sb/sth (for sth) (especially BrE) to make sb/sth suitable for a particular job: [VN, VN to inf] *His experience fitted him perfectly for the job.* ◦ *His experience fitted him to do the job.*
- **adj.** (fit-ter, fit-est)
  - **HEALTHY** 1 ~ (for sth) | ~ (to do sth) healthy and strong, especially because you do regular physical exercise: *Top athletes have to be very fit.* ◦ (BrE) *He won't be fit to play in the match on Saturday.* ◦ *She tries to keep fit by jogging every day.* ◦ (BrE) *He's had a bad cold and isn't fit enough for work yet.* ◦ *I feel really fighting fit (= very healthy and full of energy).* ◦ *The government aims to make British industry leaner and fitter (= employing fewer people and with lower costs).* —see also **KEEP-FIT** 022 UNFIT ◦ note at **WELL** ◦ vocabulary notes on page R18
  - **SUITABLE** 2 ~ for sb/sth | ~ to do sth suitable; of the right quality; with the right qualities or skills: *The food was not fit for human consumption.* ◦ *It was a meal fit for a king (= of very good quality).* ◦ *Your car isn't fit to be on the road!* ◦ *The children seem to think I'm only fit for cooking and washing!* ◦ *He's so angry he's in no fit state to see anyone.* ◦ (formal) *This is not a fit place for you to live.* 022 UNFIT
  - **READY** 3 ~ to do sth (BrE, informal) ready or likely to do sth extreme: *They worked until they were fit to drop (= so tired that they were likely to fall down).* ◦ *I've eaten so much I'm fit to burst.* ◦ *She was laughing fit to burst (= very much).*
- **noun**
  - **ILLNESS** 1 [C] a sudden attack of an illness, such as **EPILEPSY**, in which sb becomes unconscious and their body may make violent movements: [VN] **CONVULSION**: *to have an epileptic fit* ◦ *Her fits are now controlled by drugs.*
  - **OF COUGHING/LAUGHTER** 2 [C] a sudden short period of coughing or of laughing, that you cannot control: [VN] **BOUNCE**: *a fit of coughing* ◦ *He had us all in fits (of laughter) with his jokes.*

• **OF STRONG FELLING** 3 [C] a short period of very strong feeling: *to act in a fit of anger/rage/temper/plique*—see also **MISSY FIT**

• **OF CLOTHING** 4 [C,U] (often with an adjective) the way that sth, especially a piece of clothing, fits: *a good/bad/close/perfect fit*

• **MATCH** 5 [C] ~ (between A and B) the way that two things match each other or are suitable for each other: *We need to work out the best fit between the staff required and the staff available.*

022 by/in fits and 'starts frequently starting and stopping again; not continuously: *Because of other commitments I can only write my book in fits and starts.* have/throw a 'fit (informal) to be very shocked, upset or angry: *Your mother would have a fit if she knew you'd been drinking!*

**fit-ful** /'fɪtʃl/ **adj** happening only for short periods; not continuous or regular: *a fitful night's sleep* ► **fit-fully** /'fɪtʃli/ **adv**: *to sleep fitfully*

**fit-ment** /'fɪtmənt/ **noun** [usually pl.] (BrE, technical) a piece of furniture or equipment, especially one that is made for and fixed in a particular place

**fit-ness** /'fɪtnəs/ **noun** [U] 1 the state of being physically healthy and strong: *a magazine on health and fitness* ◦ *a fitness instructor/class/test* ◦ *a high level of physical fitness* 2 ~ for sth/to do sth the state of being suitable or good enough for sth: *He convinced us of his fitness for the task.* ◦ *There were doubts about her fitness to hold office.*

**'fitness centre** (BrE) (NAME 'fitness center) **noun** a place where people go to do physical exercise in order to stay or become healthy and fit

**fitted** /'fɪtɪd/ **adj** 1 [only before noun] (especially BrE) (of furniture) built to be fixed into a particular space: [VN] **BUILT-IN**: *fitted wardrobes/cupboards* 2 [only before noun] (especially BrE) (of a room) with matching cupboards and other furniture built for the space and fixed in place: *a fitted kitchen/bedroom* 3 [only before noun] (of clothes) made to follow the shape of the body: *a fitted jacket* 022 **LOOSE** 4 ~ for/to sth | ~ to do sth (especially BrE) suitable; with the right qualities and skills: *She was well fitted to the role of tragic heroine.* 5 ~ with sth having sth as equipment: *Insurance costs will be reduced for houses fitted with window locks.*

**fitted carpet** **noun** (BrE) a carpet that is cut and fixed to cover the floor of a room completely—see also **WALL-TO-WALL CARPET**

**fit-ter** /'fɪtə(r)/ **noun** 1 a person whose job is to put together or repair equipment: *a gas fitter* 2 a person whose job is to cut and fit clothes or carpets, etc.

**fit-ting** /'fɪtɪŋ/ **adj., noun**

■ **adj.** 1 (formal) suitable or right for the occasion: [VN] **APPROPRIATE**: *The award was a fitting tribute to her years of devoted work.*

◦ *It is fitting that the new centre for European studies should be in a university that teaches every European language.* 2 -fitting (in adjectives) having a particular FIT:

■ **noun** 1 [usually pl.] a small part on a piece of equipment or furniture: *light fittings* ◦ *a pine cupboard with brass fittings* 2 [usually pl.] (BrE) items in a house such as a cooker, lights or shelves that are usually fixed but that you can take with you when you move to a new house—compare **FIXTURE** 3 an occasion when you try on a piece of clothing that is being made for you to see if it fits

**Lesson 4 : Using a dictionary (2)**

**A Look at the dictionary page in Lesson 3 and answer the following questions. Then read the text below.**

Do you use a dictionary?

Why and how often do you use a dictionary?

How can a dictionary help you?

A dictionary is a collection of words. It lists the words of a language and gives necessary information about them. It tells us about the

- a) spelling
- b) pronunciation
- c) meaning
- d) parts of speech etc. of words.

To make the meanings of words clear, example sentences are given in *italics*.

Example sentences show how words are used. It also gives the synonym/s and the antonym/s of a word.

We find words made by adding prefixes and suffixes to the root word. Parts of speech are also shown. A verb word is always given in the simple present tense. But the past form of a verb and the past participle are also shown.

**B Again read the text above. Then ask and answer the following questions.**

- 1 What information does a dictionary give us about a verb word?
- 2 Why are the example sentences given?
- 3 How are new words formed?
- 4 Why are the synonyms and the antonyms given?
- 5 What do we need a dictionary for?

**C Match the sentence parts in A with those in B.**

<b>A</b>	<b>B</b>
A dictionary shows	in its simple present tense.
Prefixes and suffixes	about the words of a language.
A verb word is always given	help to make new words.
Meanings of words are given	how to pronounce a word.
A dictionary gives information	in a dictionary.

**Lesson 5 : Looking up words in a dictionary**

**A Talk in groups about the text in Lesson 4 and about the questions below. Then read the text.**

- 1 Is there any connection between the alphabet and a dictionary?
- 2 What do you understand by alphabetical order?

The words in a dictionary are presented in alphabetical order. It follows the alphabetical order of letters. It means words starting with the letter D will be before the words starting with the letter E. In the same way words starting with the letter F will come after the words starting with E.

Again the words starting with the same letter are also arranged one after another in alphabetical order in the dictionary. For example, the words dark, doctor and deep all start with the letter D. These words appear in the dictionary in the order of *dark*, *deep* and *doctor*.

To find the words with a letter, look at the words at the top of the page.

While doing the activities, use a dictionary or a dictionary page as much as you can.

**B Arrange the following words in alphabetical order.**

entertainment, knowledge, culture, art, painting, thought, interest, heritage, yellow, future

**C Work in pairs. Arrange the following words under the letter 'S' in alphabetical order as they appear in the dictionary.**

single          should          system          sufficient  
solar          source          steel          sweet

**D Find and write the words coming between the words 'tea' and 'technique' under the letter 't' in your dictionary.**

**E Show in which order are the following words arranged in Lesson 3.**

fit   fitted   fitful   fitness   fitting   fitter   fitment

### Lesson 6 : Meanings of words

**A Look at the questions below and read the following text. Now discuss in pairs**

- 1 What do you do when you want to know the meaning of a word?
- 2 How can a dictionary help us?

A dictionary gives us the meaning/meanings of a word. Example sentences are given to show how the words are used. They also help to make the meaning clear. A word may have more than one meaning.

The word 'dry' (adj) has a number of meanings. Three of them are given here.

- (i) not wet, not damp, not sticky: *The river becomes dry during the summer.*
- (ii) with very little rain: *I hope the weather remains dry during our picnic.*
- (iii) not interesting: *His speech was quite dry.*

Sometimes the synonyms and antonyms given with words help to understand the meanings of words.

**B** Find at least two meanings for each of the following words from the dictionary page in Lesson 3. Do the activities in pairs, using a dictionary.

fit fitness fitter fitting fitted

**Now, make your own example sentences showing their meanings.**

### **Lesson 7 : Synonyms and antonyms**

**A** Look at the questions and ask and answer.

- What is a synonym ?
- What is an antonym ?
- Do you know of any two words with the same or nearly the same meaning ?
- What about 'boring' and 'dull' ?
- Do you know a word that means just the opposite of another word ?
- What about 'obey' and 'disobey' ?

**B** Read the text and do the following activities in pairs.

A synonym is a word that means the same or almost the same as another word. There may be more than one synonyms for some of the words. Big and large, 'begin' and 'start' are synonyms.

An antonym is a word that means the opposite of another word. 'Sorrow' and 'happiness', 'right' and 'wrong' are examples of antonyms.

**C** Find the synonyms of the following words. Take help of the dictionary.

idle text annoyed result goal trip valuable return

**D Find the synonyms of the words in the dictionary page in Lesson 3.**

fit fitted fitting

**Make sentences with the synonyms.****E Find the antonyms of the words in the dictionary page in Lesson 3.**

fit fitted

**Make sentences with the antonyms.****F From your dictionary find the antonyms of the following words.**

profit complete strong hard different sweet fair minor

**G Match a word in A with a synonym in B.**

A	B
noise	harm
boring	sight
handy	irritate
mend	dull
damage	useful
jealous	row
annoy	envious
view	fix

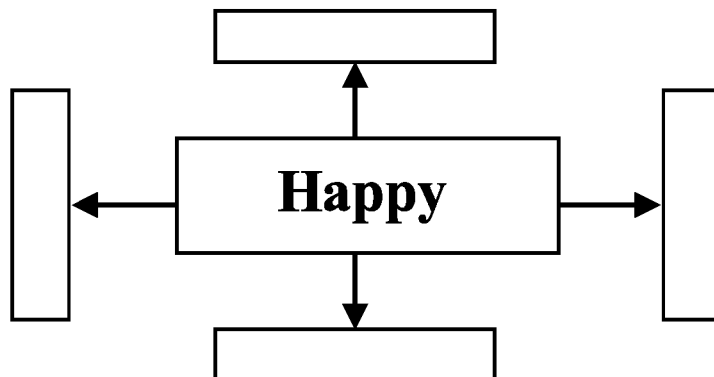
**H Fill in the boxes with the synonyms of the word 'happy'.**

**I Match a word in A with its opposite in B**

A	B
high	accept
lose	light
refuse	low
temporary	subtract
heavy	permanent
add	gain
minor	outdoor
indoor	major

**J Fill in the boxes with the opposites/ antonyms of the word ‘happy’.**

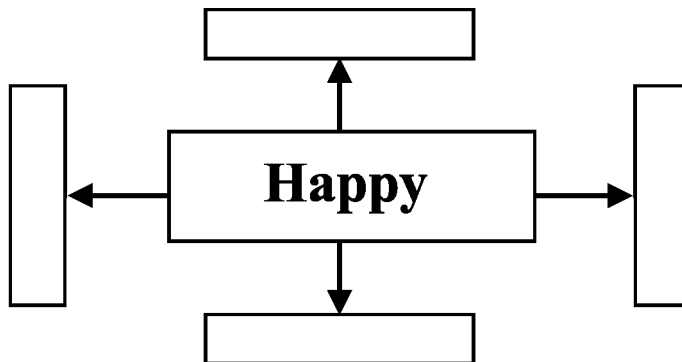



## Unit Five

# Making a difference



After we have studied this unit, we will be able to

- read and understand texts through silent reading
- infer meaning from context
- listen for information
- ask and answer questions
- write answers to questions

**Lesson 1: The beginning**

**Key words :** typical extraordinary will-power determination aspect spirit defying

**A Read the text and tick the best answers to the following questions.**

There is a small village called Bhabanipur in Jhenaidah. It is a typical Bangladeshi village. People here spend their day-to-day life mostly working in the fields and doing household work. In this ordinary village, there lives an extraordinary woman named Shamima Akhter Maya. Shamima's willpower and determination have made her extraordinary. She has seen the most cruel aspect of life. But the cruelty could not defeat her spirit. She has come out as a winner, defying all the odds of life.

Shamima is now 32 years old. She has only one son named Ashikur Rahman Kanok. She runs a small boutique called 'Oikko Nari Kollayan Shangstha' in her village. Let's hear from Shamima, how she succeeded in setting up her boutique.

*(adapted from Prothom Alo, June 17, 2005)*

- 1 Bhabanipur is a typical Bangladeshi village. The underlined word means
  - a unusual
  - b usual
  - c famous
  - d infamous
  
- 2 Shamima is an extraordinary person. Here the underlined word means
  - a common
  - b simple
  - c amazing
  - d normal
  
- 3 The people of determination succeed in the long run. Here the underlined word means
  - a willpower
  - b weakness
  - c strong desire
  - d wish

- 4 Shamima has faced the darkest aspect of life. Here the underlined word means
- appearance
  - position
  - characteristics
  - piece
- 5 The tragedy in Shamima's life could not defeat her spirit. Here the underlined word means
- ghost
  - soul
  - strength
  - wisdom

**B Read the text again. Now match the phrases with the meanings.**

	phase	meaning
1	day-to-day life	unkind happenings in life
2	household work	become victorious
3	cruel aspects of life	everyday life
4	come out as a winner	difficulties of life
5	all the odds of life	having all the regular features of a Bangladeshi village.
6	typical Bangladeshi village	domestic chores

**C Read the text again and answer the following questions.**

- What type of village does Shamima live in?
- What do the people of 'Bhabanipur' village usually do?
- What has Shamima done to make herself extraordinary?

D Write a paragraph about Shamima from your imagination. In your paragraph write what Shamima should do for the good of her own family as well as the other families in the village.

**Lesson 2 : Flash back**

**Key words:** stunned admiration adolescent heed

**A Read the text.**

Shamima started to tell us her story. Listening to her, we were stunned and at the same time our hearts were filled with admiration for her.

It was 1995. Shamima was 15 years old. She got promoted to class 8. Shamima had all the dreams of an adolescent. She wanted to bring about a change in her life. She wanted to see happiness in her family too. She knew she could fulfill her dream by completing her education and getting a good job.

Fifteen-year old Shamima's dreams were nipped in the bud. Her father wanted to marry her off against her will. Marrying off a girl under 18 is against the law in Bangladesh. Shamima did not want to get married. But nobody paid any heed to her. They arranged her marriage with a man much older than her. All her tears and protests went in vain. Shamima was married off to Kamal Uddin Joardar.

**B Choose the best answer.**

- 1 Shamima's story ..... everyone.
  - a fascinated
  - b astonished
  - c shocked
  - d worried
- 2 Shamima thought about the welfare of her .....
  - a family.
  - b friends.
  - c cousins.
  - d neighbours.
- 3 Shamima did not want to get married because she wanted to complete her education but nobody..... her.
  - a talked to
  - b listened to
  - c took care of
  - d looked after

**C Read the text again and answer the following questions.**

- 1 How long ago did Shamima begin to tell her story?
- 2 What did Shamima dream of?
- 3 Did Shamima's dream come true? What happened?
- 4 How old is Shamima now?
- 5 As an adolescent, what are your dreams?

**D Write about a person who has suffered or struggled like Shamima.**

Use the following phrases :

- pay heed to
- nip in the bud
- in vain

### **Lesson 3 : Ever beautiful Shamima**

**Key words :** outward vow disabled unstitched dignity regret ill-fated product  
grudge



**A Look at the picture. Talk about the picture and read the questions.**

- 1 Who did Shamima work with?
- 2 What is Shamima's present dream?

**B Now, read the text and ask and answer the above questions.**

Shamima's misery started the day she was married. Her husband was a greedy person and he used to abuse her verbally and physically. Within a few months into her marriage she had to leave her husband Kamal Uddin Joardar.

Now Shamima vows to work with women, who are ill-fated like her. She has 43 female members in her organisation working for her. She herself trains the members and then provides them with work. She designs fabrics, makes block-print, brush-paint and hand-embroidered saris. She also makes three-piece dresses for women, and *fatuas* for men. She sells these products in her shop and supplies them outside.

Shamima has a dream now, a dream to do something for the helpless people. She wants them to feel useful. They can live with self-respect and dignity. With this in view, she goes out looking for such people.

Shamima finished her story with a smile. Shamima has no complaints, no regrets, no grudges. Her husband could destroy her outward beauty but not the beauty of her mind. All she wants to do is to bring a smile on the faces of those women who are unfortunate. Shamima wants to become a famous designer.

- C** What do you understand by, "Her husband could destroy her outward beauty but not the beauty of her mind.?"

**D True or false? If false, give the correct information.**

- 1 Shamima's husband destroyed her.
- 2 Shamima promised to stand beside the helpless women.
- 3 She has some trainers to train the women of her organisation.
- 4 Shamima wants to become a wealthy person to help others.

- E Project:** Find a person in your locality who has succeeded in the face of difficulties and write about her/him.

## Lesson 4: A man who loves trees

**Key words :** profession sapling passion gigantic mission

### A Read the text.

At the farthest corner of Bangladesh there is a village called Tarapur. In this village there lives a man named Kartik Poramanik. He is a hair dresser by profession, but a nature lover at heart. His passion is to plant saplings, which grow into gigantic trees. He started planting trees when he was only 10 years old. He remembers what his father once told him, "My son, you can earn the blessings of God by planting trees". He has never forgotten what his father told him. At present he is 63 years old. He has planted hundreds of trees in his village. Many of the trees are now 35-40 years old.

Once there were hardly any trees in this village. Kartik used to go to different houses for his job. At times he would get tired in the scorching sun, but there were no trees under which he could sit and rest for a while. Thinking how people suffer in the heat, Kartik began his tree-planting mission.

Occasionally Kartik would wake up early in the morning, take one or two labourers with him and set out to plant trees. He would walk long distances to plant trees, carrying with him some dry food and water. He would pay all the expenses from his own pocket. Kartik has planted trees beside the roads, in and around the bazar, schools and colleges, open fields and many other places.

At times it so happened that Kartik would go to water his plants at 10 or 11 p m. People asked him, "Kartik, are you mad? What are you doing so late at night?" Kartik would smile and say, "What to do, sir. I have to work hard the whole day to earn money for my family. I don't get time during the day. But my trees would die if I don't water them. So I come late at night to look after them."

Even today this old man continues planting trees as many as he can.

A man, who can hardly sign his name, is leaving his signature all around in nature.  
(adapted from *The Prothom Alo*, December 2, 2003)

**B True or false? If false, give the correct information.**

- 1 He planted the first tree 50 years ago.
- 2 Kartik borrowed money from others to plant trees.
- 3 He would plant trees around his hut only.
- 4 At times Kartik would water his trees at night because he felt lazy during the day

**C Choose the best answer.**

- 1 Kartik was a ..... by profession.
  - a cultivator
  - b tree planter
  - c day labourer
  - d hair dresser
  
- 2 His mission is to make the village green by.....
  - a cultivating paddy in the fields.
  - b growing grass in all the fallow land.
  - c planting fodder for the cattle.
  - d planting many trees.
  
- 3 Some of Kartik's trees are big and .....
  - a great.
  - b gigantic.
  - c enormous.
  - d kingly.
  
- 4 Some of his trees are ..... years old.
  - a 15 - 20
  - b 25 - 35
  - c 35 - 40
  - d 40 - 45



**D Read the text again and answer the following questions.**

- 1 Who is Kartik Poramanik?
- 2 How do you understand that he is a nature lover?
- 3 Why did he plant trees?
- 4 What do you understand by the saying, "A man, who can hardly sign his name, is leaving his signature all around in nature"?

**Lesson 5: The truthful dove (1)**

**Key word :** shelter grumpy unwillingly generous flattery

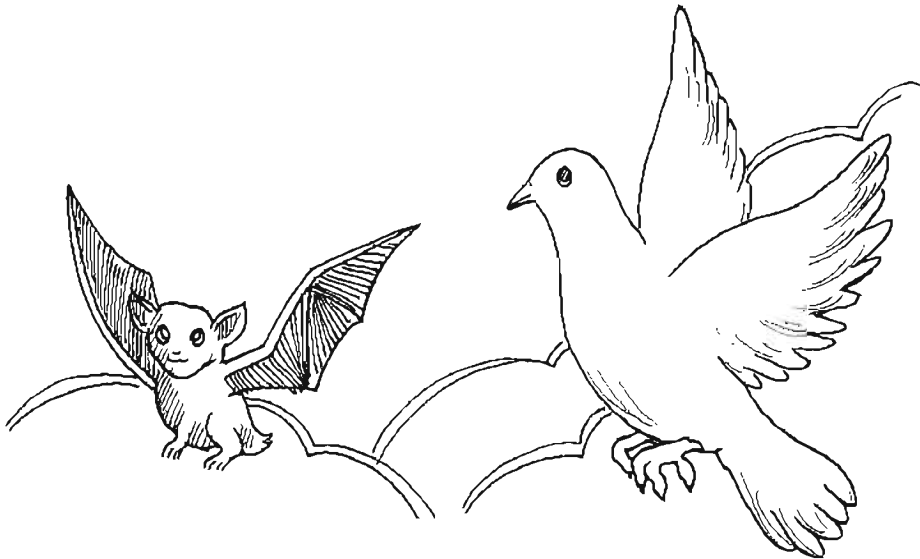

**A Talk about the picture and read the story of the dove and the bat.**

Once upon a time, a dove and a bat were very good friends. One day the two friends decided to set out on a journey. They flew over the rivers and hills and came to a big jungle. Both the friends were very tired, they needed to sit down and take a rest. Soon night fell and it was dark all around. A storm rose. It started to rain heavily. The dove and the bat started to look for a shelter.

They came upon a century-old rain tree. An owl had his nest in that tree. The dove and the bat knocked at the owl's door. The old grumpy owl opened the door. The dove and the bat requested him to give them shelter. The owl unwillingly let them in. The two birds were hungry too. They begged for some food. The selfish owl was not happy. However, he shared his dinner with them. The dove was so tired that she could hardly eat. But the bat was sly. He ate greedily. He began to praise the owl with the thought of getting more food. The bat said, "O wise and brave owl, you are the most generous person I have ever seen. You are powerful and mighty."

The owl was very pleased at the bat's flattery. He puffed and ruffled himself, trying to look as wise and brave as possible. Then he turned to the dove and asked, "Now little dove, what do you think about me?"

**B Now answer the following questions.**

- 1 Who were the two good friends ?
- 2 What did they decide to do ?
- 3 Why were they tired ?
- 4 Why did they look for a shelter ?
- 5 Where did the dove and the bat come ?
- 6 Whose nest was there on the tree?
- 7 Which words tell you that the owl was not good at heart?
- 8 Why couldn't the dove eat?
- 9 Why did the bat praise the owl?
- 10 Which words pleased the owl?
- 11 What action of the owl tells you that he wanted to hear more good things about him?

**C Read the story again and make sentences from the table.**

The dove and the bat		very tired.
	decided	to fly over rivers and hills.
They	were	to look for a shelter.
		very good friends.

**D True or false? If false, give the correct information.**

- 1 The dove and the bat decided to go for a flying competition.
- 2 They reached a big jungle.
- 3 They were afraid because a storm was blowing.
- 4 The dove and the bat were looking for a place to spend the night.
- 5 The owl gladly asked the bat and the dove to come in.
- 6 The owl and the birds ate together.
- 7 The bat sincerely praised the owl.

**E Which words would you use to describe an eagle or a crow?****Lesson 6 : The truthful dove (2)**

**Key words :** wondering insincere speech praise host grateful

**A Look at the picture and talk about it.**

**B Read more about the three birds and write answers to the following questions.**

All this time the dove was listening to her friend's false praises. She was wondering how insincere his praises were. The dove hung her head down and was quiet. The owl got impatient. He wanted to hear more praises. He looked at the dove and asked, "Don't you have any good thing to say about me?" The bat joined the owl, "Yes, don't you have any words of praise for our kind host?" The dove was ashamed of her friend bat and kept her eyes down. The owl urged the dove, "Come on, say something!"

The dove lifted her head slowly and said, "Master owl, thank you very much for the shelter you have given me, thank you for the food you have offered me. I will remain ever grateful for this".

**Questions**

- 1 What does the word 'insincere' mean in the story?
- 2 Why did the dove think that the bat is insincere?
- 3 What made the owl impatient?
- 4 Why was the dove ashamed of her friend?

**C True or false? If false, give the correct information.**

- 1 The bat was very sincere when he praised the owl.
- 2 The owl wanted to hear more good things about himself.
- 3 The dove was very harsh to the owl.

## Lesson 7 : The truthful dove (3)

**Key words:** gracious noble deserve hospitality ungrateful echo vicious leathery vain

### A Look at the picture.



- 1 What do you see?
- 2 How do the three birds look?
- 3 Why do you think they look so?
- 4 Who looks very happy? Can you guess why?

### B Read more about the three birds and find out about their fate. Work in pairs and write the answers to the questions that follow.

"What?" cried the bat. "Is that all you have to say to our gracious host? Is he not the wisest, bravest and most generous of all animals and birds? Have you no praise for his noble character as well as for his goodness to us? I am ashamed of you! You do not deserve such hospitality. You do not deserve this shelter."

"You are an ungrateful bird, and the bat is right. You do not deserve this generous hospitality which I have offered. Get out! Be off, I say!" said the owl.

"Yes, get lost!" echoed the bat, flapping his leathery wings. The two heartless creatures fell upon the poor little dove and drove her out into the dark and stormy night.

But the owl and the bat did not go unpunished for their act of heartlessness. The bat can never fly in broad daylight. He has to wait for the sun to go down. And do you know what happened to the vain owl? Well, he is blind as long as the sun is up. He cannot hunt or feed himself unless it is dark. So the two vicious creatures with their dark heart live in the dark.

On the other hand, the dove is rewarded for her truthfulness. Her name shall be used by poets as long as the world lasts to rhyme with "LOVE".

\*Adapted from *The Curious Book of Birds* by Abbie Farwell Brown

### Questions

- 1 Why did the bat say that he was ashamed of the dove?
  - 2 Why was the owl angry with the dove?
  - 3 What did the owl and the bat do to the dove?
  - 4 How were the bat and the owl punished at the end?
  - 5 What reward did the dove get?
- C Make a list of the words used in the story to describe the three birds. add some of your own words.
- Owl :  
Bat :  
Dove :
- D Discuss in groups and write the moral of the story.

## Lesson 8 : The children's song

### A Read and recite the poem.

#### The children's song

Land of our Birth, we pledge to thee  
Our love and toil in the years to be;  
When we are grown and take our place  
As men and women of our race.

Father in Heaven, Who lovest all,  
Oh help Thy children when they call;  
That they may build from age to age,  
An undefiled heritage.

Teach us to bear the yoke in youth,  
With steadfastness and careful truth;

That, in our time, Thy Grace may give  
The Truth whereby the Nations live.

Teach us to rule ourselves always,  
Controlled and cleanly night and day;  
That we may bring, if need arise,  
No maimed and worthless sacrifice.

Teach us to look, in all our ends,  
On Thee for judge, and not our friends  
That we, with Thee, may walk uncowed  
By fear or favour of the crowd.

Teach us the strength that cannot seek,  
By deed or thought, to hurt the weak;  
That, under Thee, we may possess  
Man's strength to comfort man's distress.

Teach us Delight in simple things,  
And Mirth that had no bitter springs;  
Forgiveness free of evil done,

And Love to all men, 'neath the sun!  
Land of our Birth, our faith, our pride,  
For whose dear sake our fathers died  
Head, heart and hand through the years to be!

*Rudyard Kipling*

**Word notes :**

**pledge** : make a promise

**toll** : hard work

**lovest** : love

**thy** : your

**undefiled** : pure

**heritage** : the history, traditions, buildings and qualities that a country has had for many years and that are an important part of the country's character

**yoke** : a piece of wood that holds two oxen together, while ploughing or pulling a cart

**bear the yoke** : shoulder the great responsibility

**B Read the poem silently and answer the questions.**

- 1 What do the children promise to their motherland?
- 2 What do the children ask God to teach them?
- 3 Do you like the poem? Why?



## Unit Six

# Going on a foreign trip



After we have studied this unit, we will be able to

- listen for information
- listen to and follow announcements
- read and understand texts
- ask and answer questions
- write answers to questions
- write the main ideas

**Lesson 1: At the airport**

Key words: lounge immigration

**A Look at the picture and talk about it.**

- 1 What do you see?
- 2 Can you guess where it could be?
- 3 Who are the people in the picture?
- 4 What could be their relationship?

**B Now read the text and find out if your guesses are correct.**

Zara lives with her parents in London. They have come to Bangladesh to visit Zara's aunt and uncle. She is very close to her cousin Mita. Both the families have visited many interesting places together in Bangladesh. It was great fun. Then they decided that they would visit some places outside Bangladesh too. They decided to go to Thailand. But Mita's parents were too busy with their work, so they could not go. However, Mita was going with them.

Mita, Zara and her parents are at Hazrat Shahjalal International Airport. They are waiting in the lounge. Mita is very excited. This is her first time to board a plane. They are flying by Bangladesh Biman. Mita is hoping to have a great time in Thailand.

As they wait, the two cousins start planning what they would do once they reach Bangkok. Mita's uncle brings forms for all of them to fill in before going

through the immigration. He gives one to Mita and says, "You have to give some information about yourself in the form. The immigration officer will check your passport and stamp it. And then you are ready to travel." Mita, Zara and her parents start filling in the forms.

**C Read the text again and answer the following questions.**

- 1 Why is Mita excited?
- 2 Why aren't Mita's parents going with her?
- 3 What does an immigration officer do at the airport?

**D Write a short composition about your experience of travelling to another place. It could be going to your grandparents'/aunt's/sister's/brother's house.**

Write about your preparation before travelling, your experience of the way, e.g. launch terminal, railway/bus station, airport, etc.

**Lesson 2: Filling in a form**

Key words : expire renew visa valid

**A Read the card and discuss in pairs.**



গণপ্রজাতন্ত্রী বাংলাদেশ সরকার  
Govt. of the People's Republic of Bangladesh  
(বহির্বিমান কার্ড/ Departure Card)

1. নাম Name		.....	
2. লেখ Sex	<input type="checkbox"/> পুরুষ Male	<input type="checkbox"/> মহিলা Female	3. জন্ম তারিখ Date of Birth
4. জাতীয়তা Nationality		.....	
5. পাসপোর্ট নম্বর Passport Number		6. মেয়াদ উত্তীর্ণের তারিখ Date of Expiry	
7. ফ্লাইট নম্বর Flight Number		8. প্রস্থানের তারিখ Date of Departure	
9. বাংলাদেশে অবস্থানকারী ঠিকানা (বিশেষী নাগরিকের জন্য) Address in Bangladesh (For Foreigners)			
.....			
10. বাংলাদেশের নাগরিকের জন্য For Bangladesh Nationals			
a. ভিসা নম্বর Visa Number	b. মেয়াদ উত্তীর্ণের তারিখ Date of Expiry	.....	
c. ভিসার প্রকার Type of Visa	d. ভ্রমণের উদ্দেশ্য Purpose of Visit	.....	

সীল  
Seal

.....  
যাত্রীর স্বাক্ষর  
Passenger's Signature

তারিখ:  
Date

Day	Month	Year

**B** Now, read the text about Mita, and fill in the departure card in section A on her behalf.

Mita's full name is Mita Sultana Ahmed. She was born on 6 May 1998. She got her passport on June 09, 2010. It's a five-year passport. It will expire on 8 June 2015. After that she has to renew her passport. Her passport number is AB 9842251. She is going to Thailand by Bangladesh Biman, flight number BG 88 on 14 July 2012.

Mita got her visa from the Royal Thai Embassy in Dhaka. Her visa number is T 9115138. The visa was issued in Dhaka on 29 June 2012. The visa is valid for three months. It will expire on September 27, 2012. It is a tourist visa. If you are travelling on a tourist visa, you are not allowed to study or work there.

**C** Imagine you are travelling to a foreign country. Copy the form in A and fill in with your own information. If you have a passport, use information from it. If you do not have a passport, make your imaginary passport with visa number and expiry date, passport number, date of travel, etc.

**D** Work in pairs. If you have a passport, tell your partner when you got it and which country/countries you have already visited. If you do not have a passport, would you like to have one? Why?

### Lesson 3 : Going through immigration

Key words : departure booth counter scan machine readable

**A** Look at the pictures and discuss in pairs.

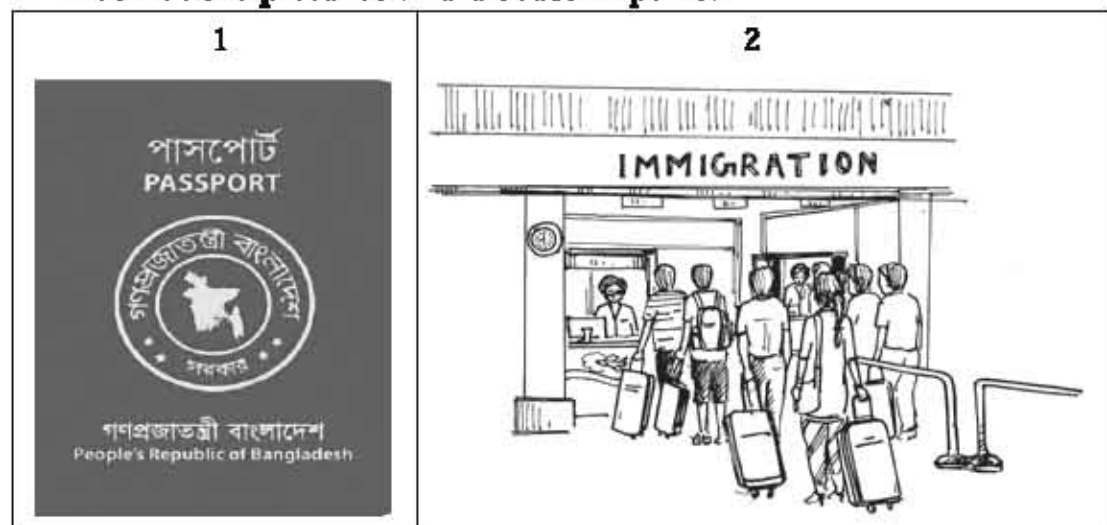

- 1 Why does a person need a passport?
- 2 What are those booths for?
- 3 Why are people standing in a line in front of them?
- 4 What are the persons doing inside the booth?

**B Read the text and answer the questions.**

Zara's parents Mrs Jhuma Islam, Mr Mazharul Islam, Zara and Mita, fill in their departure cards and move towards the immigration counter. Mita stands in front of one of the booths. She hands in her passport and the departure card to the officer.

The immigration officer goes through Mita's passport, visa and the departure card. "Are you travelling alone?" asks the officer. "No. I'm going with my aunt, uncle and cousin," says Mita.

"They are right there on that counter."

"Is this your first visit to Thailand?"

"Yes."

"How long are you going to stay there?"

"Seven to ten days."

"Where are you going to stay?"

" In a hotel."

The officer is talking as well as going through Mita's papers. He finds the papers OK. He smiles and stamps her passport. The officer keeps the departure card, and returns the passport to Mita.

"Have a safe journey."

"Thanks."

Mita waits for her aunt, uncle and Zara on the other side of the immigration. Once all of them are done, they walk towards the passengers' departure lounge.

**C Make a list showing what the immigration officer asks and tells Mita, and what Mita says in response. One is done for you.**

Immigration officer	Mita
1 Are you travelling alone?	1 No. I'm travelling with my aunt, uncle and cousin.
2	2
3	3
●	●
●	●

**D** Now, work in pairs and act out the role of Mita and the immigration officer.

**E** What are the three things needed at immigration?

#### Lesson 4: Boarding the plane

Key words: seize enclosed formality gel

**A** Read the text and answer the following questions.

Mita, Zara, Mr and Mrs Islam all sit at the lounge. They all have hand luggage with them. Mr Islam asks, "Mita, Zara, are you two carrying any liquid, lotion, gel or cream in your carry-on luggage?" "I have a small lip gel in it. Why Uncle?" "Well, if it is a very small one, there is no problem. But if you've more than 100 ml, you have to put it in the checked-in luggage. These are not allowed on board in hand luggage. For security reasons, the officials who do the baggage checking will seize and throw them away". Mita, Zara, Jhuma Islam and Mazharul Islam go through the security checking and wait in the enclosed area. All the formalities are done. Now they are waiting to board the plane.

Mita, Zara and her parents board the plane after their row number is announced. Mita gets a window seat. Her seat number is F23 C. Zara sits beside her on an aisle seat and her parents sit behind them.

#### Questions

- 1 Who had a small lip gel in the hand luggage?
- 2 How much liquid or gel is allowed to carry in hand luggage?

- 3 Why are liquid, gel and cream not allowed on board a plane?
- 4 Which row is Mita sitting in?

**B Listen to the teacher/CD and complete the chart. First one is done for you.**

**U1, L4 B**

**Listening text: 3**

Announcement	Information
1. Destination	1. Bangkok
2. Name of the Airways	2.
3. Flight no.	3.
4. Row numbers of passengers called first to board	4.
5. Rows called for boarding last	5.
6. Final call for boarding	6.

### Lesson 5: Announcements on board (1)

**Key words:** lavatory cruising altitude descend schedule destination

**A Look at the picture and talk about it.**



**B Read the announcement carefully and fill in the blanks below.**

Ladies and gentlemen, welcome on board Flight BG88 to Bangkok. We are currently third in line for take-off and are expected to be in the air in approximately seven minutes. Please fasten your seat belt and secure all baggage under your seat or in the overhead compartments. Keep your seats and table trays in upright position for take-off. Please turn off all personal electronic devices, including laptops and cellphones. This is a non-smoking flight. Smoking in the lavatory is prohibited. Thank you for choosing Bangladesh Biman. Enjoy your flight.

- 1 The plane is \_\_\_\_\_ in line to take off.
- 2 The passengers are requested to fasten their \_\_\_\_\_.
- 3 All baggage to be kept \_\_\_\_\_ the seat or in the \_\_\_\_\_ compartments.
- 4 The seats are to be in \_\_\_\_\_ position.
- 5 All personal \_\_\_\_\_ devices are to be turned off.
- 6 It is a \_\_\_\_\_ flight.

**C Read the questions carefully. Now read the following announcement on board flight BG 88 and answer the questions in short.**

- 1 Who is speaking?
- 2 What is the airspeed of the plane per hour?
- 3 What's the time mentioned in the announcement?
- 4 How is the weather?
- 5 What's the temperature in Bangkok mentioned in the announcement?
- 6 Who will serve snacks and drinks?



Good afternoon passengers. This is your captain Rashid Akbar speaking. First I'd like to welcome everyone on Flight BG 88. We are currently cruising at an altitude of 10058.40 feet at airspeed of 643.7376 km per hour. The time is 1:25 pm. The weather looks good and with the tailwind on our side we are expecting to land in Bangkok approximately fifteen minutes ahead of schedule. The weather in Bangkok is clear and sunny. The temperature is 32 degree Celsius for this afternoon. If the weather is good we should get a great view of the city as we descend. The cabin crew will be coming around in about twenty minute's time to offer you a light snack and drinks. The inflight movie will begin shortly after that. I'll talk to you again before we reach our destination. Until then, sit back, and enjoy the flight.

### Lesson 6: Announcements on board (2)

**Key word :** exit locate monitored assistance secure assume bracing-position pouch firmly turbulence

**A Look at the picture and talk about what the cabin crew is doing and why she is doing so.**

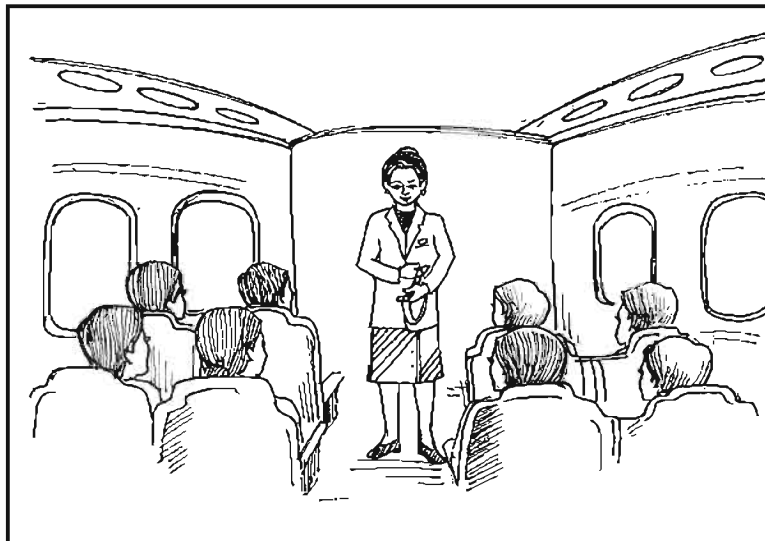

**B Listen to the teacher/CD and answer the questions.**

**U1, L6 B**  
**Listening text: 4**

- 1 What is the announcement about?
- 2 How many times has the word 'belt' been said in the announcement?
- 3 What will you do to fasten your seat belt?
- 4 What will you do to unfasten your seat belt?

**C Read the text.**

Oxygen and the air pressure are always being monitored. In the event of a lack of oxygen, an oxygen mask will automatically appear in front of you. Pull the mask towards you and place it firmly over your nose and mouth. Secure the elastic band behind your head, and breathe normally. If you are travelling with a child or someone who requires assistance, secure your mask first, and then assist the other person. Keep your mask on until a uniformed crew member advises you to remove it.

In the event of an emergency, please assume the bracing position. That is, lean forward with your hands on top of your head and your elbows against your thighs. Ensure your feet are flat on the floor.

A life vest is located in a pouch under your seat or between the armrests. When instructed to do so, open the plastic pouch and remove the vest. Slip it over your head. Pass the straps around your waist and adjust at the front. To inflate the vest, pull firmly on the red cord, before you leave the aircraft. We remind you that this is a nonsmoking flight.

You will find this and all the other safety information in the card located in the seat pocket in front of you. We strongly suggest you read it before takeoff. If you have any questions, please don't hesitate to ask one of our crew members. We wish you all an enjoyable flight.

*Adapted from: English club.com, airodyssey.net*

**D Read the announcement again and match the sentence parts in A with those in B in the following table. Then write the sentences in your exercise book.**

A	B
1 Oxygen and air pressure	under the seat or between the armrests.
2 If you are travelling with a child	are used to draw attention.
3 Life vests are placed	is kept in the seat pocket.
4 The whistle and light	put the mask on your nose and mouth first and then help the child.
5 The card with other safety information	are always monitored.

**E Choose the best answer.**

- 1 There are more than two emergency exits in the aircraft. Here 'exits' means
  - a) doors
  - b) departures
  - c) windows
  - d) seats
- 2 In the announcement, the cabin crew asked each passenger to ----- their life vest.
  - a) trace
  - b) take
  - c) find
  - d) uncover
- 3 During emergency, the passengers are requested to assume the bracing position. Here, 'assume' means-
  - a) take on
  - b) suppose
  - c) shoulder
  - d) change

4 The cabin crew with their nice behaviour made all the passengers feel safe and ..... when the plane was bumping.

- a) worried
- b) fixed
- c) happy

### Lesson 7: Reaching Bangkok

**Key words:** derived parallel cargo capacity

**A Look at the picture and talk about it.**

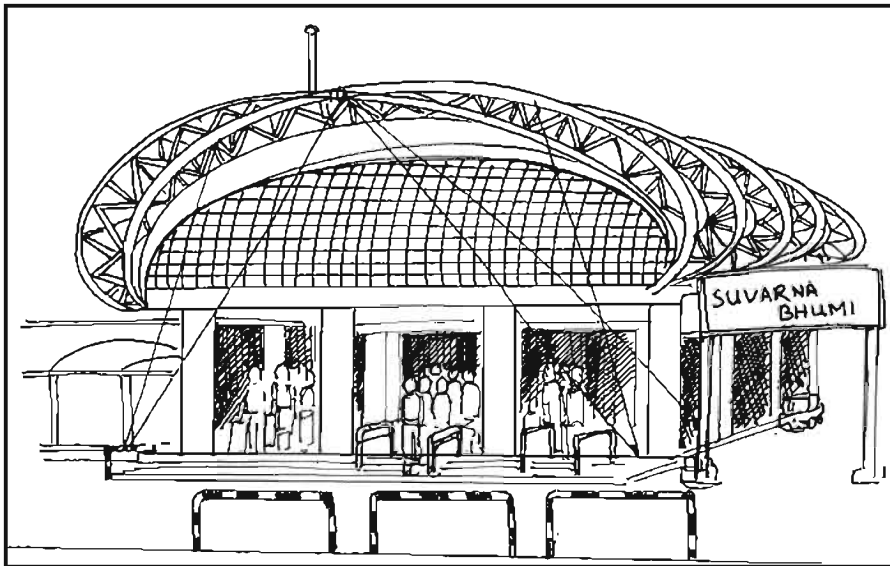

- 1 What do you see?
- 2 What could be this place?
- 3 How do you know?

**B Read the text and complete the chart.**

The plane landed at Suvarnabhumi Airport at 4:55 p.m. The name ‘Suvarnabhumi’ is pronounced as “su-wan-na-poom”. The name is derived from Sanskrit, which means golden land. The name was chosen by King Bhumibol Adulyadie.

The airport is located in Racha Thewa in the Bang Phli district of Samut Prakan province, 30 kilometres east of Bangkok.

The airport has two parallel runways. Both of them are 60 metre wide. One of the runways is 4000 metres long and the other is 3,700 metres. It can handle 76 flight operations per hour. It can handle 45 million passengers and 3 million tonnes of cargo per year.

The airport passenger terminal is 563,000 square metres that is, 6,060,000 square feet. It is the fourth biggest passenger terminal building in the world. The airport is going through phase 2. It will raise its capacity to handle 65 million passengers per year. The airport has two 5-storey car park buildings. The buildings can house 5000 cars.

<b>Bangkok Airport</b>	<b>Information</b>
1 name	
2 origin of the name	
3 chosen by	
4 meaning	
5 distance from Bangkok	
6 runway	
7 length of runways	
8 aircraft control per hour	
9 number of passengers	
10 cargo handled	
11 car parking	
12 number of passengers in future	

**C Listen to the teacher/CD and circle the correct information.**

**U1, L7 C**  
**Listening text: 5**

**Questions**

Suvarnabhumi Airport has

- 1 checkpoints for arrivals: 130/131/132
- 2 checkpoints for departures : 70/71/72
- 3 custom control checkpoints for arrivals: 25/26/27
- 4 custom control checkpoints for departures: 4/6/8
- 5 baggage conveyor belts: 20/22/24
- 6 check-in counters: 360/361/362
- 7 moving walkways: 106/107/108
- 8 elevators: 102/103/104
- 9 escalators: 81/82/83

**Lesson 8: The destination**

**Key words:** fascinate destination floating market

**A Read the text below and complete it with the right form of verb from the box. You can use one verb more than once if necessary.**

be wait give excited nod go hold take ride stand

Mita was \_\_\_\_\_ to see such a big airport. After completing immigration, they all came out of the airport. Mr. Mazharul Islam \_\_\_\_\_ to the taxi counter and bought a ticket. They stood in a line and \_\_\_\_\_ for *their turn*. Soon their taxi came and they all got into it.

Mita's uncle \_\_\_\_\_ the driver his address, Happy Condo 18 Rachada Pisek Road. The driver \_\_\_\_\_ and started for the destination. Mita \_\_\_\_\_ very excited. She \_\_\_\_\_ Zara's hand and whispered, " Oh Zara, I can't believe I'm here with you and I'm so happy. Mita had never \_\_\_\_\_ a car at such a high speed. She \_\_\_\_\_ *a little scared*. It \_\_\_\_\_ about one and a half hours to reach their destination. Mita's uncle paid the driver according to the metre. The driver \_\_\_\_\_ out their luggage, thanked Mr. Islam and drove away.

### **B Read the text and answer the following questions.**

Mita looked around and saw a garden of trees and flowers welcoming her. There was a small fountain at the middle of the garden, bringing in cool breeze. Mita loved the place.

Mita brought a suitcase as well as a piece of carry-on luggage. She carried her luggage to the elevator and pressed a button that *said 6*. Her uncle's apartment was on the 7th floor. It was a nicely done two- bedroom apartment. Mita and Zara were going to share the same room.

It was nearly 8 p.m. when they all *got settled*. They finished dinner and started to plan for the next day. Mita read about the floating market in the internet, and wanted to see one. "Well, then you have to wake up very early tomorrow. The market sits early in the morning and is over before noon. We are going to the Tha Kha floating market tomorrow," said Mr. Islam. "Wow!" cried out Mita and Zara together. "Thank you, uncle." "Thank you, dad."

### **Questions**

- 1 Why did Mita think that the garden was welcoming her?
- 2 When did they all start to plan for the next day?
- 3 What did they plan to see?
- 4 Why would Mita and Zara wake up early the next morning?

**C Read the text in A and B and write what the following phrases mean in the text.**

- 1 their turn
- 2 a little scared
- 3 bringing in
- 4 said 6
- 5 got settled

**Lesson 9: The Tha Kha floating market**

**Key words :** laden chit-chat natives

**A Look at the picture and talk about it.**



- 1 Can you guess what this could be?
- 2 Where do you think this place is?

**B Read the text and answer the questions.**

It was Sunday. Mita, Zara, Jhuma Islam and Mazharul Islam woke up very early. They quickly got ready and started for Tha Kha floating market. They planned to have breakfast at the market. They reached the market place sharp at 7. The canals were surrounded with coconut palm trees. They hired a boat. The boatman started to row slowly taking them to the centre of the market.

There were boats everywhere. The sellers were mainly elderly Thai women. Their small boats were laden with bundles of lotus flowers, farm-fresh coconuts,



fruits, vegetables, local food, and delicious sweets. The sellers and buyers rowed their boats slowly. The sellers displayed their goods for sale and the buyers chose their pick. They could have a little chit-chat as buying and selling was going on.

- 1 What kind of market was it?
- 2 Why did the boatman row slowly?
- 3 Who were selling goods? How were they selling their goods?
- 4 What were they selling?
- 5 What was the atmosphere at the market?

**C Read more about the Tha Kha river and Mita's experience.**

The Tha Kha floating market is more traditional with a few tourists visiting than other floating markets. Originally, the Tha Kha floating market used to sit only six or seven days a month depending on the phase of the moon. Nowadays, the trade takes place on Fridays, Saturdays and Sundays too. The main buyers here are the Tha Kha natives. People seem to know each other very well. Everyone was seen smiling and calling each other by name. The locals did not notice Mita and others much. They were all busy buying and selling.

**D True or false? If false give the correct information.**

- 1 Tha Kha floating market is a tourist place.
- 2 It sits only six or seven days a month.
- 3 The buyers and sellers are the local people living near Tha Kha river.
- 4 They all knew each other.

**E Read the text further and write the answers to the following questions.**

- 1 Why is Tha Kha floating market 'traditional'?
- 2 How many days a week does the market sit?
- 3 Why do you think people at the floating market know each other so well?

**F Read the text and answer the following questions.**

They passed an hour and a half at the market and enjoyed the business. Then all of them were hungry. They rowed near the boat of an elderly woman, who was selling food. She welcomed them with a smile and showed them the foods. They bought the traditional and very popular food called 'Pad Thai', a kind of noodles with shrimps, tomato and some vegetables, with freshly roasted crushed peanut. The food was served in a bowl made from banana leaf. After Pad Thai, they ate 'Kanom Krok'. It is a coconut pancake which is very sweet. The Tha Kha people are simple and easy going. They are very friendly and polite. They do not understand English or any other language. Yet they have a way to communicate with Mita and others.

Mita was delighted to see a traditional Thai floating market. She took a lot of pictures with the elderly sellers.

**Questions**

- 1 Who were hungry?
- 2 How did the elderly woman know that Mita and others want to buy food?
- 3 What does the phrase 'easy going' mean?

**G Discuss in groups the following question and write the answer.**

Do we have anything like a Tha Kha market in our country? If we have, where can you find it? If we don't have, discuss why we need it.

**H Describe a nearby bazar/market in your locality by answering the following questions:**

- a. What is the market called? (give its name if there is any) How far is it from your home?
- b. When does the market sit?
- c. What can you buy at the market?
- d. Do you like going to the market? If you do, write why.

## Unit Seven

# Different people, different occupations

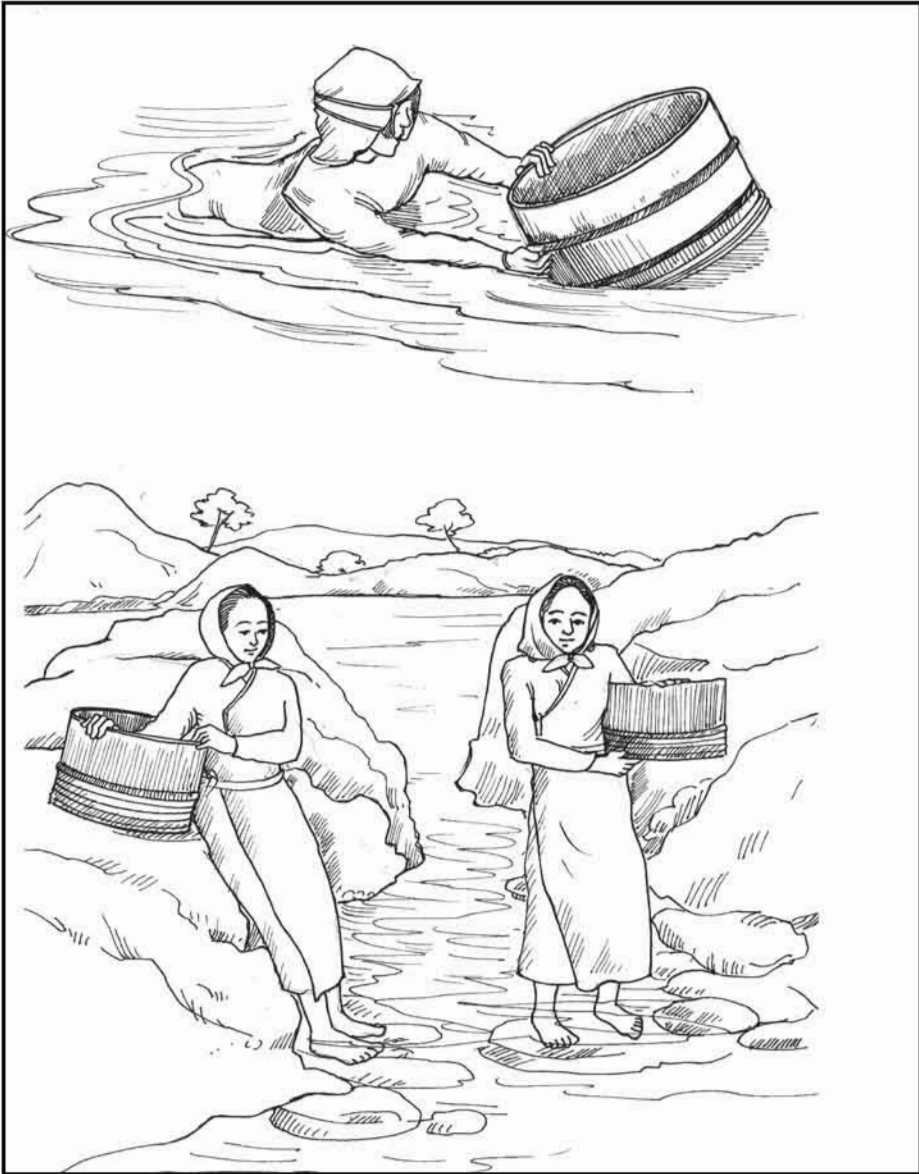

After we have studied this unit, we will be able to

- read and understand texts through silent reading
- listen for information
- ask and answer questions
- write down the main ideas in our own words
- write short paragraphs

**Lesson 1: Pearls! Pearls! Pearls!**

**Key words :** mythology ancient dissolved status unparalleled association delicate

**A Look at the pictures and discuss in pairs.**

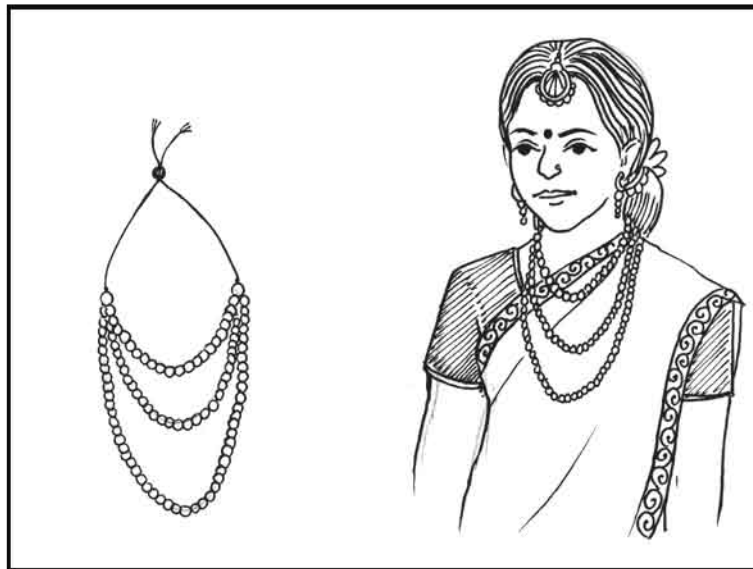

**B Read the text and answer the questions that follow.**

Thousands of years ago, the first pearl was probably discovered while human beings were searching for food at the sea shore. Throughout history, the pearl with its shine has been one of the most highly valued gems.

Pearls have been mentioned many times in religious texts and mythologies from the earliest times.

The ancient Egyptians valued pearls so much that they were buried with them. It is said that the famous queen of Egypt Cleopatra would dissolve a pearl in a glass and drink it as a sign of love and respect for the entire nation.

The Greeks thought of pearls as a sign of wealth and social position. The beauty of pearls was associated with love and marriage.

In ancient Rome, pearls were considered the greatest sign of wealth and social status.

At that time the young women of noble families loved to wear beautiful pearl necklaces. The brave knights used to wear them in the battles for good luck.

**Questions**

- 1 Do you think 'pearls' were discovered by accident? Why?
- 2 Why do you think pearls were valued so much in the past?
- 3 What good luck the knights thought would pearls bring them?

**C Read the text in B again and write the information in the table.**

Who	When/ where		
The ancient Egyptians	wore	pearls	
The Greeks			
The ancient Romans			
The brave knights			

**Lesson 2: The Ama divers**

**Key words :** rare descend hazardous rely

**A Read the text and answer the questions.**

Before the beginning of the 20th century, pearls were obtained from pearl oysters. These oysters were collected from the bottom of the ocean, lake or river.

To get enough pearl oysters, free-divers were often forced to descend to the depth of more than 100 feet in one breath. Because of the difficulty of diving, pearls at that time were of different quality as well as very rare.

In Asia some pearl oysters could be found on shoals at a depth of 5–7 feet from the surface. At times the divers had to go 40 feet or even up to 125 feet deep to find enough pearl oysters. These deep dives were extremely hazardous to the divers.

**Questions**

- 1 What is the text about?
- 2 Where did the people get the pearls from?

**B Read about the Ama divers of Japan. Discuss in pairs the information that you have got from the text and answer the questions.**

In some fishing villages along the coast of Japan, there are amazing groups of women known as 'Ama divers'. These women worked and are still working as Ama. The word 'Ama' means 'women of the sea or sea women'. They are independent divers. They make their living by diving. They can dive to the depth of the sea up to 25 metres. And they dive without using oxygen tanks or other breathing equipment.

The Ama divers rely on their own skills and breathing techniques. They use that skill and technique to push themselves down to the bottom of the sea and back to the surface again. They can hold their breath for up to two minutes. Careful watching, lung capacity and hunter instincts are the special qualities of Ama divers.

However some of these young villagers are going to the city for other jobs. The remaining Ama divers are now aged between 50 and 60. But there are still some who continue to dive even at their 70s. If the young people do not take up Ama diving, soon this profession will die out.

**Questions**

- 1 Why are the Ama divers amazing?
- 2 How deep can the Ama divers go down into the sea?
- 3 What techniques and skills do the Ama divers use in diving?
- 4 Why do you think are the young villagers going to the city?

### Lesson 3 : River gypsies in Bangladesh (1)

**Key words :** gypsy ethnic nomadic roam tarpaulin tents remedy vend heal talisman

**A Look at the pictures and discuss with your partner what you see**

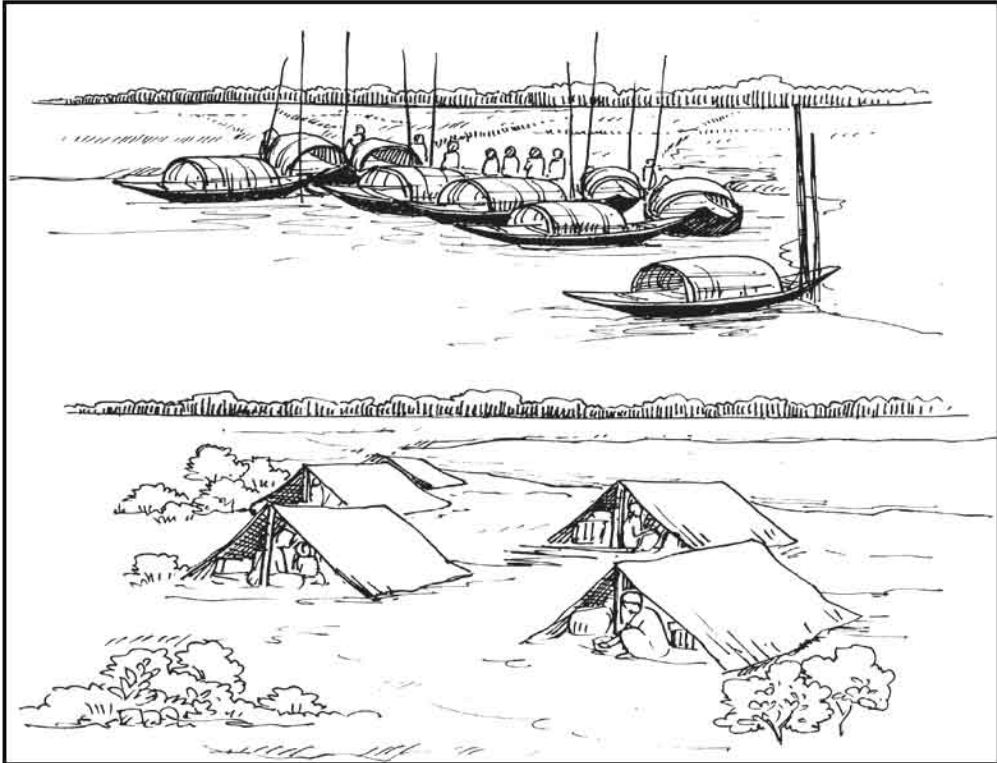

**B Read the text and answer the following questions.**

River gypsies are an ethnic group of people in Bangladesh. They are known as *bedey* to local people. The gypsies have their own lifestyle and culture. They live in groups and do not own any land. Therefore, they live a nomadic life, travelling from one place to another. These people roam across our rivers and waters from May to December in small country boats. These boats are their houses and these people are a part of our waters. In winter, many water bodies dry up. At that time they return to the mainland and live in make-shift tarpaulin tents on open river banks. You can see their men relaxing in the tents. Toddlers play with dogs or other pets in the dust. Women often idle away time by hair doing, picking off lice in twos or threes sitting in a row.

Throughout the monsoon, they remain busy with fishing. They also dive for natural pearls in waters. Sometimes, they camp for a couple of weeks. Men catch snakes and entertain people with snake charming and sell herbal cures. Women go from door to door to sell bangles, cosmetics and other things. They also try to heal pains of old people often by sucking out blood from their body.

Many villagers believe in the magical power of the gypsies. They can make an evil spirit leave someone's body by magic or special powers.

- 1 Who are river gypsies?
- 2 How do they live?
- 3 What do river gypsies do in winter?
- 4 What do river gypsy men do for a living?
- 5 What do river gypsy women do for a living?

**B Discuss with your partner and circle the right answer.**

- 1 The term 'ethnic' is connected to
  - a people.
  - b plants.
  - c animals.
  - d fishes.
- 2 River gypsies roam around on their boats about .....months a year.
  - a six
  - b seven
  - c eight
  - d nine
- 3 River gypsies live in tents in
  - a summer.
  - b winter.
  - c monsoon.
  - d spring.
- 4 The term 'nomadic' refers to a person who
  - a stays permanently at a place.
  - b travels from place to place.
  - c lives in one's own house.
  - d lives in a rented house.



**C Listen to the teacher/CD and fill in the following gaps with right word/s.**

**U7, L3 C**  
**Listening text: 6**

- 1 The river gypsies are among the Nation's ----- groups.
- 2 A 2007 report said ----- percent live below the poverty line.
- 3 Only 2 percent of gypsy children are given primary ----- .
- 4 Most gypsy children travel with their parents for an ----- 8 months of the year.
- 5 So, they end up in a cycle of -----.

**D** In summer vacation last May, Sohan went to Lauhajang in Munshigonj to visit his maternal uncle. His elder cousin, Jihan studies sociology at Dhaka University. One afternoon, Jihan took Sohan to a *bedey* camp to know about their life. They talked to a middle aged *bedey* woman who was cooking in front of her tent. Read the conversation and do the following activity.

- Jihan : Good afternoon. Can I ask you a few questions ?
- Woman : Good afternoon. Umm..... you see I'm busy cooking. I've to feed my son and then...
- Jihan : Well, I won't take much time. Just a few questions if you please....  
How long have you been here in this camp?
- Woman : Four months. Since last January. And if it rains, we're going to rivers again next month.
- Jihan : What do you do for a living?
- Woman : We catch fishes. Our men are snake charmers and we heal toothache and joint pains of old people.
- Jihan : How do you heal people?
- Woman : With traditional herbs and healing art.
- Jihan : Well, if you don't mind, how much do you earn?
- Woman : Not enough. About 3000 taka per month. Now many people don't believe in our remedies. They go to doctors. So we go to remote villages...
- Jihan : What about your son? I guess he is already 5. Does he go to school?
- Woman : Not yet. But I've heard about mobile boat-schools in rivers. I'll try to find one for my son.

- E** Suppose you were with Sohan. Ask the *bedey* woman some more questions that you would like to. For example, you can ask questions to know about her family members, their names, age, work, their past living places, future plans, food habit, etc.
- F** Have you ever seen any gypsies/*bedey*/snake charmers or any person selling things from door to door in your area? Write your experience about any one of them.

#### Lesson 4 : River gypsies in Bangladesh (2)

**Key words :** survive used to inherit mainstream petty trick integral part  
community settle urbanise (v) urban (adj)

- A** Look at the pictures. Discuss with your partner and say who they are, where they are, what they are doing, etc.



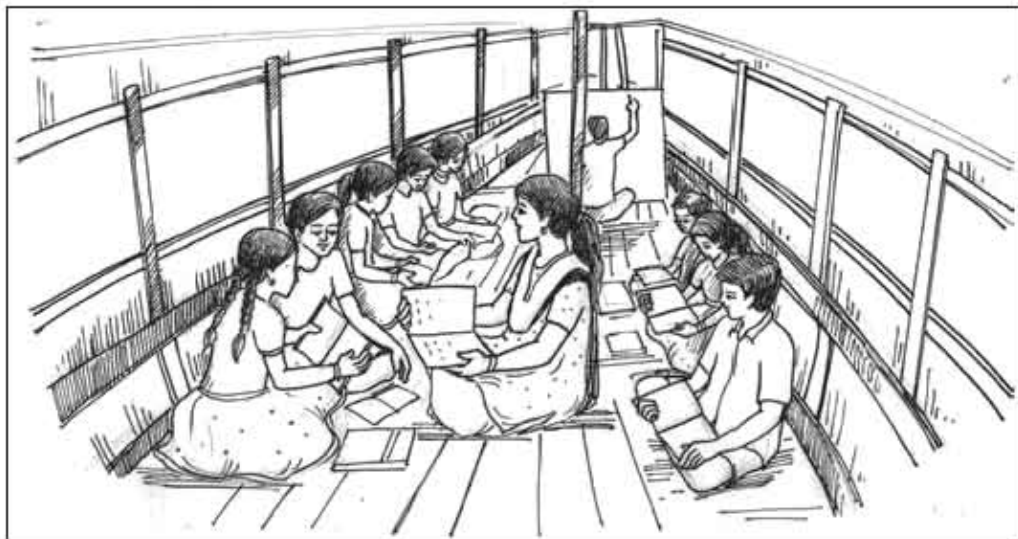

**B Read the text and answer the following questions.**

River gypsies in Bangladesh are having various problems. First, Bangladesh is getting urbanised very rapidly. Gypsy people are losing their customers in urban population. Hence, their income is threatened. Secondly, 24,000 kilometres of previous waterways has shrunk into only 6,000 kilometres in the country in dry seasons.

Scientists believe that Bangladesh will be worst affected by global climate change. The unpredictable rain and drying out of rivers have made boat movement heavily restricted. Thirdly, many river gypsies are changing their lifestyle in the context of changed reality. They are thinking of living permanently on land. The authority feels that river gypsies need help to survive in the mainstream population. Therefore, the government is offering voting rights, permanent housing and bank-loan facilities. However, changes do not come overnight.

Traditionally, river gypsies are used to water life. They have inherited from their forefathers necessary life skills to survive in waters. They have no education and training to adapt to mainstream modern society. So the authority feels the need to bring them under formal education network. But they have no permanent living place. Gypsy children are born and brought up on roaming boats. Therefore, they cannot go to conventional schools. And hence, mobile boat-schools are coming up for gypsy children. Some voluntary organisations are running special schools on boats to educate river gypsy children in some areas.

## Questions

- 1 What are the main problems that river gypsies are facing?
- 2 What is the effect of global climate change in Bangladesh?
- 3 Why are many river gypsies thinking of changing their lifestyle?
- 4 Why can't river gypsy children go to conventional schools?
- 5 Who are running special schools for river gypsy children? Why?

### C Listen to the teacher/CD and tick the best answer.

<b>U7, L4 C</b> <b>Listening text: 7</b>
---

- 1 *Bedeys* catch snakes during the winter/rainy/summer season.
- 2 Females of the *bedey* families contribute to the family income/education/health with petty trades.
- 3 They sometimes go vending far from home by rickshaw/ on foot/ by cart.
- 4 Many *bedeys* have settled near the riverbanks/lakesides/seashore.
- 5 *Bedeys* are an integral part of our history and literature/culture/tradition.

### D Imagine there is a boat-school in your area to teach river gypsy children. Write a short composition about how you can help the gypsy children with learning.

# Unit Eight

## News! News! News!



### Learning outcomes

After we have studied this unit, we will be able to

- ask and answer questions
- participate in short dialogues and conversations on familiar topics
- read aloud texts with proper sounds, stress and intonation
- read and understand text materials
- write answers to questions
- write simple formal/informal letters
- write simple CVs
- write short paragraphs

### Lesson 1: News! News! News! (1)

**Key words :** whizz master(v) compute computer-nerd passion monitor database claim website evidence emigrate gifted

**A Look at the following picture. Discuss with your partner what you see in it.**



**B Read the news report and answer the following questions.**

#### *Computer whizz kid eyes record books*

A six-year-old boy from Bangladesh is hoping to become the world's youngest computer expert.

Wasik Farhan-Roopkotha turned six in January 2012. He is hoping his skills will be recognised by Microsoft and Guinness World Records.



Wasik started to show a talent for computers since early childhood. Before the age of four, he mastered playing video games and typing in Microsoft Word.

His mother Cynthia Farhan-Risha said, "I knew he was very different since his birth. I couldn't believe my eyes when he began computing as a seven-month-old child.

At his local primary school, Wasik was above the average level. So his parents decided that he should be taught at home.

According to his mother, Wasik's English is still limited. However, he has a few words to say in Bengali.

"I really enjoy playing on the computer and learning new skills," Wasik told the BBC.

"My ambition is to be a computer expert at a big computer firm in the future."

Wasik is a computer-nerd. But he still enjoys mixing with other children, playing football and listening to music. However, computers are his main passion.

Farhan-Risha hopes that Wasik will be mentioned in Guinness World Records. They have not yet listed anyone as the youngest computer programmer in the world.

Guinness World Records said, "We do not monitor such a record in our database at the moment. But Wasik's family is welcome to make a claim on our website."(adapted from *The Daily Star*.)

### Questions

- 1 What is the report about?
- 2 Do you find the story interesting? Why?
- 3 Wasik's mother says, "I knew he was very different since his birth". Find two/three phrases/sentences that support her statement.
- 4 What is Wasik's ambition?
- 5 Do you feel proud of Wasik? Why?

**B Complete the following sentences with words/phrases form the box. There are more words than necessary.**

as well as   therefore   by the way   hence   however   anyway

Wasik is a British national (a) ----- a Bangladeshi citizen. He was born in Bangladesh and then his parents emigrated to the UK. He is a minor boy of six. But he is gifted with an extraordinary talent. He was sent to the local primary school. (b) -----, he was above the level of the average students. (c) -----, his parents decided that he should be taught at home. He is fond of friends and music. But his main passion is computer. He, (d) -----, claims the recognition as the youngest computer expert of the world. And (e) -----, the Guinness authority has asked his family to make a formal claim.

**C A reporter came to interview Wasik. Following is the interview. The questions are missing. Discuss with your partner and write what they might be. Then act out in pairs. The first one is done for you.**

Reporter : Congrats, Wasik! Guinness authority recognises you as the youngest computer expert of the world.

Question: *How do you feel now?*

Wasik : Great! It's a great feeling. After all, it's a place in the Guinness Record Book. I feel proud.

Reporter : ----- ?

Wasik : I'll do my higher education in computer science and start my own computer firm in future.

Reporter : ----- ?

Wasik : Although I'm a British citizen now, originally I'm from Bangladesh.

Reporter : We know, you like your motherland. ----- ?

Wasik : To be frank, I love my country. And I often visit Bangladesh. Every year we spend our summer in Bangladesh.

**D Now add a few more questions that you, as a reporter, would like to ask Wasik.**

**E Write a letter to your cousin about Wasik's story.**



## Lesson 2 : News! News! News! (2)

**Key words :** bunk off mass people objective bias broadcast refer editorial  
informative educative

**A Look at the following pictures. Discuss with your partner what you see in them.**

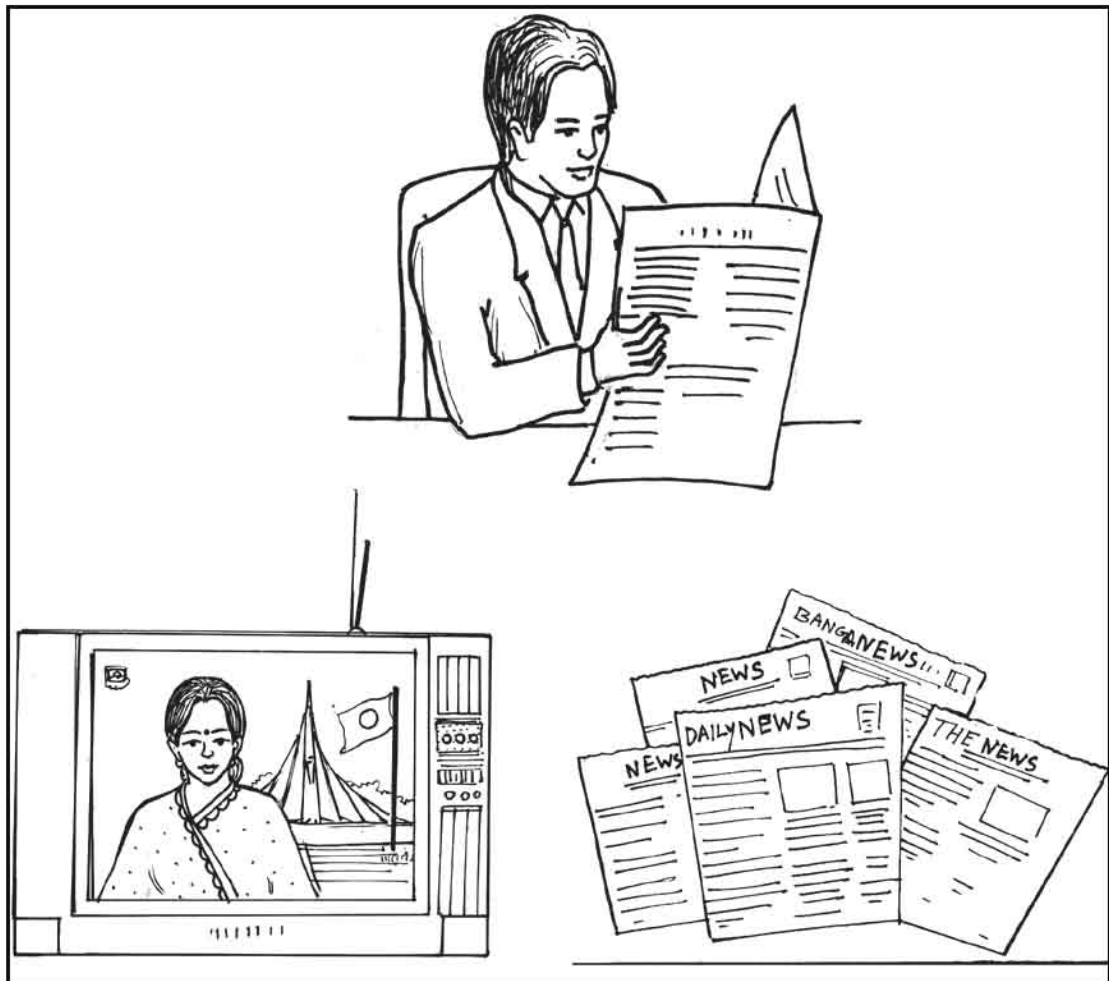

**B Read the text and answer the following questions.**

'I eat rice every day. I play cricket. I don't *bunk off* school, blah...blah...  
blah...!' These are common events. They happen every day or on some occasions.

Are these events news? Should they be published in newspapers? The answer is a big 'NO'. Then what is news anyway? What do we want to know from the *media*? 'When a dog bites a man that is not news, but when a man bites a dog that is news,' says Charles Anderson Dana.

The first thing is that the news should be a piece of information. Secondly, the information should be recent or new, and hence it is 'news'. Thirdly, mass people should take interest in it. Fourthly, it should be self-explained. That is, it should answer all the questions with who, which, what, where, when, why and how. Finally, it should be *objective*. Recently, another aspect has been added: news is either printed or *broadcast* or on the internet.

There are opinions that the term 'news' comes from 'new'. Others say it is news because it comes from all directions: North, East, West and South.

### Questions

- 1 What features should news have?
- 2 What is the difference between news and an event?
- 3 '.....it should be self-explanatory...'. What does 'it' mean here?
- 4 What are the opinions about the term 'news'?
- 5 What must be there in the information in a newspaper?

**C** Pairwork. Find the following words/phrases in italics in the text in B. Discuss with your partner and try to guess their meaning from the context. Then look at the table below and match the words with their meanings in the right column. First one is done for you.

Word/phrase	meaning
bunk off	not influenced by personal feelings/opinions
media	to send out programmes on TV or radio
objective	ways of getting information e.g. Radio, TV, newspaper, etc
broadcast	stay away/leave school/work without permission

**D** Work in pairs. Suppose, a man in your locality really bites a dog. Imagine you are a reporter and you interview the man. Share with your partner and write the dialogue. Then act that out in pairs. Use the 'why, when, what, etc' questions.

**E** Look at the following comment.

*The advertisement is the most truthful part of a newspaper.* ---Thomas Jefferson

Now, make similar sentences from the following substitution table.

The editorial page	is	the most attractive	part of a newspaper.
The cartoon page		the most educative	
The sports page		the most valuable	
The learners' page		the most interesting	

**F** Ask and answer with your partner.

- 1 Do you read any newspaper/magazine?
- 2 When do you usually read it?
- 3 Which newspaper/magazine do you read?
- 4 What makes it different from other newspapers/magazines?
- 5 Which news items do you like most ---- international affairs, sports, movie, culture, politics, etc?
- 6 Do you share your favourite news item/s with your friend/s?

**G** Write a paragraph on your habit of reading newspapers. You can take your cues from the questions in section F.

**Lesson 3: News! News! News! (3)**

**Key words :** news item headline overcome challenge vocational survive boutique forum appreciation award atmosphere profession entrepreneur

**A Match the following headlines with the given news items.**

<b>Headlines</b>	<b>Given Items</b>
<p><b>1. Hungary gets new president</b></p>	<ul style="list-style-type: none"> <li>• The International Monetary Fund Tuesday rejected a call by a US anti-Iran group for it to cut its relations with Tehran's Central Bank in order to adhere to US and European sanctions...</li> </ul>
<p><b>2. 1 in 7 US newspapers now digital</b></p>	<ul style="list-style-type: none"> <li>• Nearly one out of seven newspapers in the United States is now a digital one, an industry group said Tuesday...</li> </ul>
<p><b>3. Asia to surpass the West in wealth by 2030</b></p>	<ul style="list-style-type: none"> <li>• The Hungarian parliament yesterday confirmed Janos Ader, a co-founder of Hungary's ruling Fidesz party and close ally of Prime minister Viktor Orban, as the country's new president</li> </ul>
<p><b>4. IMF rejects call to cut ties with Iran</b></p>	<ul style="list-style-type: none"> <li>• Myanmar leader Aung San Suu Kyi was sworn in as a member of parliament yesterday, opening a new chapter in the Nobel Laureate's near-quarter century struggle against military rule.</li> </ul>
<p><b>5. Suu Kyi joins parliament</b></p>	<ul style="list-style-type: none"> <li>• Southeast Asian nations, China and India together, may surpass the US and Europe combined in terms of wealth by 2030 if the Asian economies take quick steps to overcome challenges and reduce risks, says an ADB publication in Manila.</li> </ul>

**B Read the passage and answer the following questions.**

With only 2,500 taka in her pocket, Rona Begum began her small business. She also had a sewing machine from her sister. She attended a six-month vocational training run by the Department of Youth Development before that.

Rona's Utsab Tailors Training and Sales Centre began in 1997.

Fifteen years later, she now owns a small production house of fashion garments. Traditional items, block print works and embroidery are done at her production house. "Despite serious trouble in my personal life, I worked very hard to survive," said Rona.

She supported herself by working at three places. At a time she worked at a local diagnostic centre, at a private medical college, as well as at her own training and boutique centre. She continued this till 2007.

"At first, I got almost no support from my family. Instead, I faced objections. But I'm happy now and busy with my business. The atmosphere at home has also changed," said Rona.

Ms Rona has just started several more commercial projects with partners. She decided to expand business earlier. But she did not get support from any bank or financial institutions. Then she joined the Women Business Forum (WBF), Sylhet and things started to change. At present, she is the General Secretary of WBF, Sylhet.

In the last 15 years, Rona received much appreciation and a number of awards. Along with other awards, she received Jatiya Juba Padak in 2012. (adapted from *The Daily Star*.)

**Questions**

- 1 Do you think the story is news? Why?
- 2 Where is Rona from? How can you be sure of that?
- 3 Which fact in the story can be a clue that Rona was educated?
- 4 What will you mention as the main factor behind Rona's success?
- 5 Why could she not expand business earlier?
- 6 What has Rona started with partners?
- 7 What has happened to the atmosphere at home?

**C Listen to the teacher/CD carefully and tick the best answer.****U8, L3 C****Listening text: 8**

- 1 Rona received the Divisional Youth Award of Sylhet in 2005/2008/2009.
- 2 Her stall 'Utsab' got the second award/medal/prize at the Meena Mela in Sylhet, organized by Dhaka Ladies Club in 2006.
- 3 The Meena Mela in Sylhet was sponsored/arranged/ organized by Dhaka Ladies Club.
- 4 In 2010 and 2011, Rona trained a group of poor widows/women/workers in a training programme in Sylhet.
- 5 Jatiya Juba Padak was awarded in a fashion show/function/workshop in Dhaka.

**D Pairwork. Discuss with your partner and give a suitable headline to Rona's story in section B.****E Imagine you are a reporter. Interview Ms Rona. Ask her to talk about her struggle and success. Write down and act out the dialogue in pairs.****F Do you know of any man/woman in your locality who got to a high position from a low position through struggle? Write about his/her story.****Lesson 4 : Walk-in interview! Join the winning team!**

**Key words :** career opportunity maximum negotiable curriculum vitae  
 electronic media public opinion public relations positive negative

**A Listen to the teacher/CD carefully and fill in the blanks with right word/s.****U8, L4 A****Listening text: 9**

- 1 Newspaper, radio, TV, etc together are called -----
- 2 Newspaper belongs to -----

- 3 The media can build up ----- rapidly.
- 4 Social workers should use the media for -----.
- 5 ----- is seen as a positive use of the media.

**B Discuss in groups and give arguments in favour of or against the use of ads on TV.**

**C Look at the following advertisement and answer the following questions.**

***Job opportunity***

Some healthy, young male and female are needed for security work .

**Education** : class 8 passed,

**age** : 25 maximum,

**experience** : not required,

**salary** : negotiable.

Apply with handwritten CV, 1 copy photograph, and certificate/s on or before 15 June 2015.

Manager,  
ABC company Ltd.,  
36/A/1 Tejgaon, Dhaka.

**Questions**

- 1 Who is the employer ?
- 2 Can you type your CV to apply for the job ?
- 3 Who should you apply to ?
- 4 Can a candidate without any experience apply ?
- 5 Can you imagine the size of the photograph you should send with your application ?
- 6 When can the candidate know about his/her salary ?

**D Suppose you are going to apply for the job advertised in section C. Use the following model of a CV with your own information. Add at least two more pieces of information.**

<i>Curriculum Vitae</i>	
1. Name	:
2. Father's name	:
3. Mother's name	:
4. Mailing address	:
5. Date of birth	:
6. Nationality	:
7. Educational qualifications	:
8. Experience	:
9. ....	:
10. ....	:

**E If a computer is available at your school, compose the CV and display it in your classroom for everyone.**



### Lesson 5: Apply with your CV

**Key words :** evening shift practically trainee instructor

**A** Look at the following picture. Where do you think it is? Discuss with your partner what you see in it.



**B** Read the news report. Discuss with your partner and answer the following.

Rumi Akhter Rina, 13, is in class 8 at Prime School in Chittagong. She dreams of becoming an electrical engineer.

A daughter of a day labourer, she has never believed her dream would come true. She has never thought she could be an electrical engineer.

But an opportunity came. She took part in a six-month vocational training programme. And that raised her hopes high.

In the evening shift, she took training in electrical and house wiring at the training centre. The centre is run by an NGO in Bahaddarhat area of Chittagong city.

After the training, she can now install calling bells, motor connections, tube lights, electric fans and so on.

The name of the project is "Vocational Skills Training for Urban Working Children in Bangladesh". Under this project, the NGO provides training to poor children in Chittagong. The United Nations International Children's Emergency Fund or UNICEF is funding the project.

The training shows how things can be done practically. Lessons about safety measures are also given.

The instructors are always present during the practical training sessions as part of safety measures.

Each trainee is given Tk 50 per day as a tiffin allowance. (Adapted from *The Daily Star*.)

### Questions

- 1 What did Rumi Akhter dream?
- 2 Why did she never think she could be an engineer?
- 3 Which organization is funding the training project?
- 4 Every child has rights to education, rights to safety, rights to food and nutrition, etc. Do you think the NGO tries to ensure those rights for the trainees? How?

**C Have you heard of UNICEF before? The basic information on Unicef is given below. Write a paragraph on UNICEF using the information.**



Information	
Name	United Nations Children's Fund (UNICEF)
Old name	United Nations International Children's Emergency Fund (UNICEF)
Established	December 1946, immediately after the end of the Second World War
Headquarters	New York, USA
Work zone	190 countries and territories of the world
Main focus	<ul style="list-style-type: none"> <li>• Child survival and development</li> <li>• Basic education for children and gender equality</li> <li>• Children's rights and protection</li> </ul>

**D Look at Rumi Akhter's application below.**

15 June 2011

The Programme Director

Vocational Skills Training Project

30 Shantibagh

Bahaddarhat, Chittagong

Dear Sir

I am Rumi Akhter of class 8 at Prime School. I like your vocational training course and want to take the training with the next batch. So I am sending my CV along with this application.

I would request you to register my name as a trainee of the evening batch. Thank you.

Yours sincerely

Rumi Akhter, Class 8, Roll No. 12

Prime School

Chittagong.

Now, suppose the same NGO is going to run a Computer Training Project in your area. Write an application as a trainee. Use an imaginary address of the NGO.

**E** Rumi got an interview letter from the director of Vocational Skills Training Project. She appeared on the due date. Following is the interview. First act out the interview with a partner with proper sounds, stress and intonation. Then read it silently and answer the following questions.

Rumi : Good morning, sir.

Director : Good morning. Please take your seat. What's your name, please?

Rumi : Thank you, sir. My name is Rumi Akhter.

Director : Well Rumi, where are you from?

Rumi : We are originally from Potia in Chittagong district. But my family now lives in Bahadderhat.

- Director : Your application says you want to register with the evening batch. Can you just tell us why?
- Rumi : I attend school on the day shift. So I cannot take the training at the same time.
- Director : So you don't want to hamper your regular studies. That's good... By the way, what's your future plan?
- Rumi : Sir, I want to study engineering in future.
- Director : I hope your dream will come true. You are taken with the evening batch. Good luck!
- Rumi : Thank you, sir.
- Director : You're welcome.

### Questions

- 1 Where is Rumi Akther from?
  - 2 Why does she want to register with the evening batch?
  - 3 What is her future plan?
  - 4 What do you think about Rumi Akhter's future plan?
- F** Pairwork. Suppose, you have been called for an interview with the Programme Director of the computer training project. Discuss with your partner and write an imaginary dialogue between you and the Director. (Take your cue from the model shown in section E above).

## Unit Nine

# Things that have changed our life



### Learning outcomes

After we have studied this unit, we will be able to

- ask and answer questions
- participate in short dialogues and conversations on familiar topics
- read aloud texts with proper sounds, stress and intonation
- read and understand text materials
- write answers to questions
- write short paragraphs

### Lesson 1: The wheel

**Key words :** circular rotate axis propeller turbine mobility journey (v) vehicle invention civilisation

**A Look at the pictures and say which one is easier to move and why.**

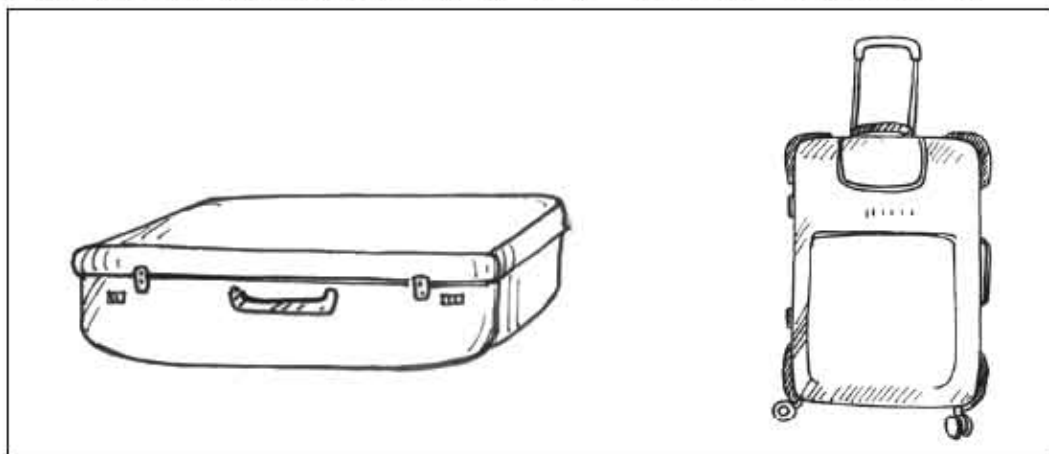

**B Read the text and answer the following questions.**

Human beings have invented many important things so far. They have brought great civilization to the world through these inventions. Do you know which invention is the greatest? It is 'the wheel'.

A wheel is a circular object. It can rotate around its axis and help easy movement of things across a surface.

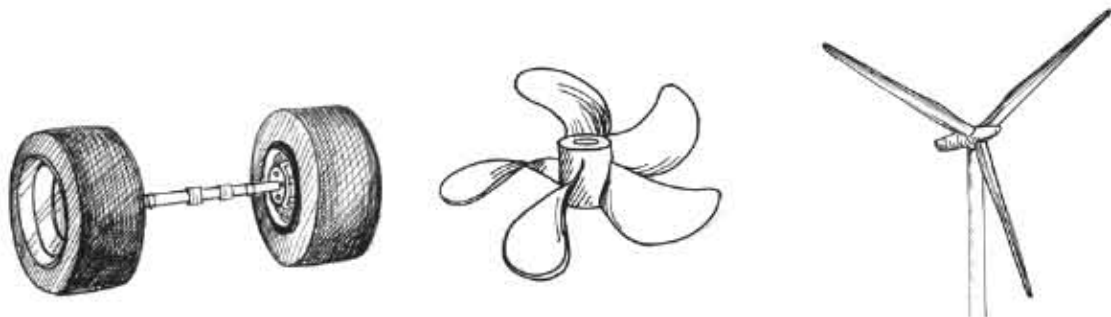

The wheels are, in fact, everywhere. They are on our cars, trains, planes, wagons and so on. Besides, they are on most factory and farm equipment. Fans, propellers, turbines are also other types of wheels.

So the wheel is very important. We cannot imagine modern life without wheels. But do we know exactly who made the first wheel?

### Questions

- 1 What is a wheel?
- 2 What can a wheel do?
- 3 Where can you find wheels?

**C Fill in the blanks with appropriate words from the box. There are more words than necessary.**

difficult much circular important heavy first

Although the wheel is a very (a) ----- invention, the history of its origin is unknown. Experts guess that the first wheel was developed from a circular object. The early man observed that a huge piece of stone could be rolled easily if it was (b) ----- in shape. Similarly, a heavy tree-trunk is (c) ----- to carry; but it can be rolled away with less effort. Even, a gigantic tree-trunk can be moved easily using other small and round trunks as rollers under it. Thus, early man took advantage of rolling objects and developed the (d) ----- wheel. Apart from its mechanical advantage, a wheel's mobility has contributed (e) ----- to the civilisation.

**D Make as many correct sentences as you can using the substitution table. In the third column there are more items than necessary.**

1. The wheel		a type of wheel.
2. A plain wheel	is	around its axis.
3. It	has	one of the simplest machines.
4. A propeller	rotates	wheels on vehicles and machines.
		helped in rapid progress of civilisation.

- E** Have you ever travelled by bus or car? Do you have any experience of what happens if one wheel falls flat. If yes, give a description of your experience. If no, imagine such a situation, and write a paragraph on it.

## Lesson 2: The history of the wheel

**Key words :** invent valley ancient further pioneer warfare

- A** Look at the following pictures of wheels. They existed in different ages in history. Discuss with your partner and put ordinal numbers under them (in spelling, such as 'first', 'second', etc.,) beginning from the to the modern times.

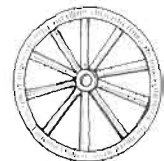
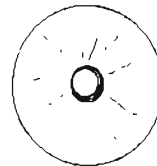
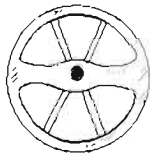
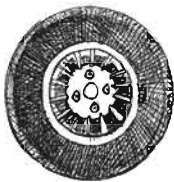

- B** Read the following dialogue between the English teacher, Mr Ramis and a student Rubina.

Mr Ramis : You know that the invention of the wheel has helped to create a new civilisation. But do you know who first used wheels?

Rubina : No teacher. But I guess it may be the Greeks.

Mr Ramis : The Greeks were pioneers in many things. But in this case, however, the Mesopotamians were the first. The oldest ever wheel was discovered in Mesopotamia. It was in 3,500 B.C.

2020 Rubina : Where is Mesopotemia?



Mr Ramis : Well, Mesopotamia was in ancient Iraq. It was along the valley of the rivers Tigris and Euphrates. After the Mesopotamians, the wheel was further improved by the Egyptians. They first made wheels with spokes. Then they used them on chariots around 2000 BC.

Rubina : So the wheel travelled to Egypt from Mesopotamia?

Mr Ramis : Exactly. But it travelled eastwards too. Wheels reached the Indus valley by 3000 B.C. But chariots with spoked wheels were made in ancient India in around 1500 B.C. They were used for war, hunting and racing.

Rubina : What about the Greeks, teacher? Didn't they use wheels?

Mr Ramis : They definitely did. In 1500 BC, the Greeks too learnt the idea of wheel-making from the Egyptians. They also made further improvements on it. Later, the Romans did the same too and produced a variety of wheeled vehicles.

**C Read the statements below and say whether they are true or false. If false, give the right answer.**

- 1 The Greeks were the pioneers in developing spoked-wheels.
- 2 The earliest wheel was discovered in 2000 B.C.
- 3 The Egyptians first used wheels on chariots.
- 4 The Romans first used wheeled chariots for warfare.
- 5 The ancient Indians used wheels before the ancient Romans did

**D Look at the following map of ancient river-valley civilisations and discuss their locations in the map with your partner.**



**E Listen to the teacher/CD carefully and complete the following sentences with appropriate words.**

**U9, L2 E**  
**Listening text: 10**

- 1 Shang China lies ----- the far east of India.
- 2 The Indus and Ganges valley is ----- the middle.
- 3 The Tigris and Euphrates valley lies ----- the Nile and the Indus-Ganges.
- 4 The Ganges flows ----- the north of India.
- 5 The Bay of Bengal is ----- the east coast of India.

**F Discuss in pairs and make as many ‘wh’ questions as you can from the given answers below. First one is done for you.**

1 i) *Where does Mesopotamia lie?*

ii) *Which countries does Mesopotamia lie between?*

Ans. Mesopotamia lies between India and Egypt.

2 .....?

Ans. The Caspian Sea is on the north of Mesopotamia.

3 .....?

Ans. The Nile falls into the Mediterranean Sea.

4 .....?

Ans. The river Yangzi lies to the east of India.

5 .....?

Ans. The Tigris and Euphrates run on the west of Mesopotamia.

**G Write a paragraph on the history of the wheel. Take your cues from the dialogue in section B.**

### **Lesson 3 : The fastest wheel on earth**

**Key words :** high-speed record-breaking network expand conventional  
unconventional magnetic trainset

**A Look at the pictures of some of the fastest trains on earth and talk about them with your partner.**



**B Read the text and answer the following questions.**

**The TGV**

**The TGV (*Train à Grande Vitesse*, meaning *high-speed train*) is France's high-speed rail service.**

It started in the 1970s. Originally, it was powered by gas turbines. But in 1973, the TGV was changed into electric trains. The TGV service first started between Paris and Lyon in 1981. Later, the network connected other cities in France with Paris.

A TGV test train set the world record for the fastest conventional wheeled train on 3 April 2007. It reached the speed of 574.8 km/h (357.2 m/h) on the test run. But the regular TGV trains operate at the highest speed of 320 km/h (200 m/h). It is the present world record of speed of a conventional commercial train.

### **The Bullet Train**

**The Bullet Train** is the network of high-speed train service in Japan. It started operation in 1964 on a limited route. But at present, most major cities of Japan come under the network.

The Bullet Train runs at a maximum speed of 300 km/h (186 m/h). It plans to increase speed up to 320 km/h (200 mph). In 2003, Japan set the world record for unconventional magnetic trainsets. In a test run, the speed was 581 km/h (361 mph). But it is not yet in regular commercial operation.

### **The High-speed Rail**

**The High-speed Rail** service in China started operation on April 18, 2007. Currently China has started building a high-speed passenger rail network. It will be similar to French TGV or Japanese Bullet Trains. The usual top speed of China's conventional quick trains is 300 km/h (186 mph).

Recently China has set the world record of a speed of 487.3 km/h (303 mph). In 2011, this record was set by an unconventional magnetic *trainset* called the "Harmony Express". This is the highest speed of an unconventional magnetic *trainset* in regular commercial operation.

**C** Read the above text in section B again. Now discuss with your partner to fill in the blank slots in the following grid with the information about high-speed trains.

Name of the country	Name of the train/train network	Year of introduction/start	Top speed of conventional train	Top speed of unconventional train	Holds world record for

**D** Discuss in groups to decide which of the above three rail services you like best and why. Finally write a paragraph and present it in the class.

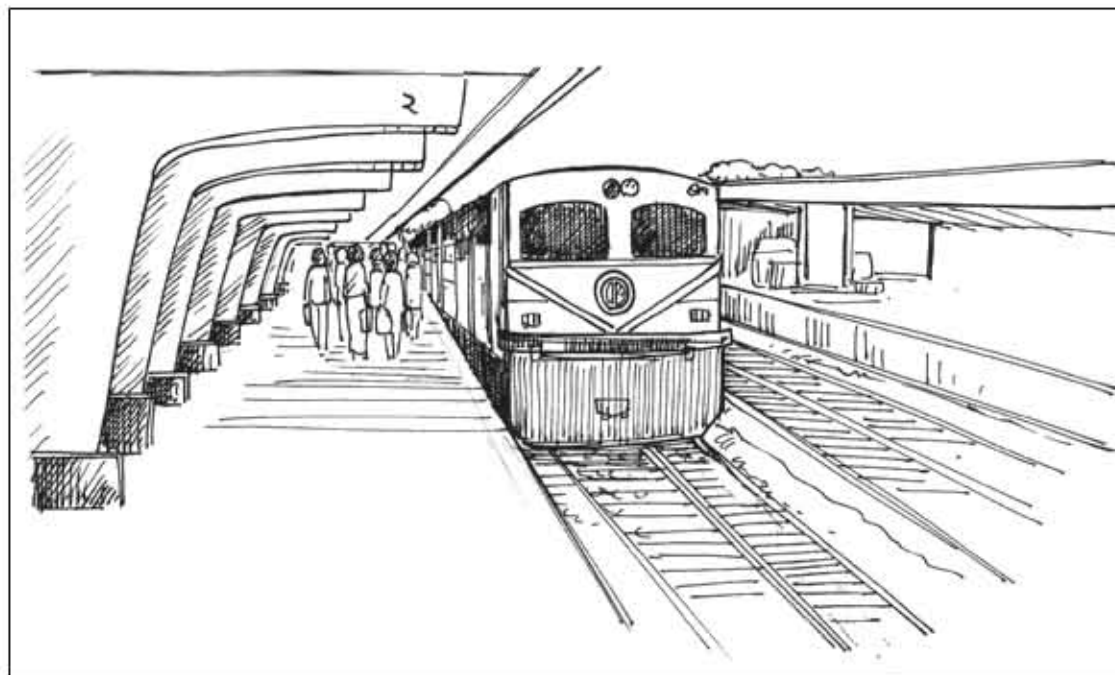

**E Pair work. Read the basic information about Bangladesh Railway below. Share with your partner and write a composition using the information.**

Name: Bangladesh Railway

- Headquarters: Dhaka
- Zones: Eastern and Western
- Numbers of stations: 459; number of engines: 284; number of passenger carriages: 1,245; number of wagons: 1,2948
- Total length of railroad: 2,855 kilometres; passengers transported annually: 42 million; total number of employees: 34,168
- Nature of present operations: international (Dhaka-Kolkata); inter-city; local

**F Work in pair. Imagine your partner is a railway official and you are a reporter. You asked questions and the official gave the above information (section E) in answers. Discuss and write what the questions might be.**

**For example:**

- 1 What is the official name of our rail service?
- 2 Where is the headquarters of Bangladesh Railway?

**Now continue...**

- 1 .....
- 2 .....
- 3 .....
- 4 .....
- 5 .....
- 6 .....

**Lesson 4: Taking off**

**Key words:** endeavor supersonic speed revolution aviation ads website  
neither ground (v) sky's the limit

**A Look at the picture and discuss with your partner what it is and where you can find it.**



**B Read the text and answer the following questions.**

Human beings conquered the distance on earth by discovering wheels. They endeavored further. Then on December 17, 1903, the Wright brothers in America made the first experiment of flying in a plane. In the experiment, a machine carried a man and rose above by its own power. *The machine was called 'aka airplane'*. It flew naturally in a smooth speed, and finally landed without damage. That was human being's first real take-off. And now, they have got a supersonic speed. In a supersonic speed, something travels *faster* than sound! So *the sky's the limit* now!

Modern aircraft companies are making revolutions in aviation technology. Boeing as well as Airbus is producing modern passenger airplanes. These planes fly very fast. Boeing 787 flies 950 km/h. However, Airbus 350 is expected to fly in a couple of years. Its speed will be 945 km/h.



You find attractive ads on the websites of both Boeing and Airbus planes. Both have excellent features. But in speed, neither could beat the Concorde. It is the



world's *fastest* supersonic passenger aircraft. Its normal speed was 2,170 km/h. The Concorde was a joint project by France and Britain. It started passenger flight in 1976. Unfortunately, the Concorde fleet was grounded forever in 2003 after a major accident.

### Questions

- 1 Who made the first successful experiment in flying an airplane?
- 2 What was the first flying machine called?
- 3 What do you mean by 'supersonic'?
- 4 What was world's fastest passenger airplane?
- 5 When was Concorde fleet finally grounded?
- 6 When is Airbus 350 expected to take off?

**Note:** The speed of sound, which is approximately 760 miles per hour is called 1 Mach. An airplane flying less than 1 Mach or less than 760 miles per hour is travelling at subsonic speed. Faster than 1 Mach or 760 miles per hour would be a *supersonic speed*.

**D Read the dialogue between the English teacher Mr Ramis and Sohan. Then do the following exercise:**

Sohan : Teacher, in the last class we read about modern aircraft. There were Boeing 787s, Airbus 350s, Concorde and so on. But which one is the best? Which one can we buy for our Biman Bangladesh Airlines?

Mr Ramis : A difficult question. There are certain things to consider. If you think of speed, Concorde flies the fastest. To many, it looks the most beautiful. But it's no more in operation.

Sohan : Between the other two aircraft?

Mr Ramis : Well, if you remember, Boeing 787 travels 950 km/h. So you see, it's not as fast as Concorde. But it's faster than Airbus 350.

Sohan : Yes teacher. I remember Airbus 350 travels 945 km/h. It's 5 km shorter than Boeing 787.

Mr Ramis : Nice calculation! But there are other factors too. Say, passenger capacity, production cost and many more. Airbus 380 now is the largest and can carry more passengers than any other aircraft. Authorities have to consider so many...

Sohan : Yes teacher. I understand.

**Complete these statements using the correct form of words in the brackets.**

- 1 Airbus 350 is a bit ..... (slow) than Boeing 787.
- 2 Concorde flew the ..... (fast) among all passenger aircrafts.

- 3 Even sound cannot travel as ..... (fast) as Concorde.
- 4 In supersonic speeds, Concorde flies ..... (high) in the sky than Boeing.
- 5 To many, Concorde looks ..... (beautiful) than other passenger aircrafts.
- 6 Airbus A380 is the ..... (large) passanger aircraft in the world now.
- 7 Airbus A380 can carry ..... (many) passengers than Boeing 787.

**E Project Work:** Work in groups. Suppose, your teacher will buy a mobile hand set. Visit in pairs a nearby mobile phone shop. Make a list of different models of handset with their price and other features. Then discuss with your partner to compare and decide which one will be the best handset and why. Share your findings with other groups.

### Lesson 5: Future aircraft

**Key words :** withstand space base launch detach monitor hypersonic  
research melting point

**A Look at the pictures and say what they are. Discuss with your partner.**



**B Read the news report adapted from the Guardian.**

The Falcon Hypersonic Technology Vehicle-2 (Falcon HTV-2) is the fastest plane ever built by human beings. It would fly from London to Sydney in less than an hour. Supersonic Concorde, by the way, could not fly at such a great speed. At the same time it would withstand temperatures of almost 2,000 degree C. This temperature is hotter than the melting point of steel.

The US Defense Agency will launch the Falcon HTV-2. First, they will set it on the back of a rocket. Then they will launch both into the space from an Air Force Base. The plan goes like this: engineers will launch the Falcon HTV-2 into the space on the back of a rocket; then they will detach the plane from the rocket; the plane Falcon will fly towards the Earth; engineers will guide and monitor it in its flight. The plane would fly at hypersonic speed of 13,000 mp/h. This speed is about 20 times the speed of sound.

The Falcon was born in 2003. It was born as part of a US military project. The project researched and built a special type of plane. The researchers wanted that the plane could reach any part of the world in less than an hour. They also wanted to use it for any purposes, military or civil. The plane was already tested in computer models.

The Falcon Hypersonic Technology Vehicle-2 would be mankind's dream aircraft in the days to come.

**Questions**

- 1 What is HTV-2?
- 2 What is the speed of HTV-2?
- 3 Describe the steps of HTV-2 test flight.
- 4 Why was the HTV-2 developed?
- 5 Do you think that HTV-2 will be 'mankind's dream aircraft'? Why do you think so?

- C** Imagine you are a TV reporter. You have come to interview the chief engineer of the HTV-2 Launch Project. What questions will you ask him/her? Design a short dialogue between yourself and the engineer, and write it. Finally act it out in pairs with proper sounds, stress and intonation.
- D** Listen to the teacher/CD carefully and complete the following sentences with appropriate words.

**U9, L5 D**  
**Listening text: 11**

- 1 Thursday's flight will test another ----- of the aircraft.
  - 2 The plane is made of ----- composite materials.
  - 3 The plane will fly at ----- speed.
  - 4 In the flight, the body ----- of the plane could reach 2,000 degree Celsius.
  - 5 ----- will melt at 2000 degree Celsius.
- E** The following passage is based on the information in section B. Read the text in B again. Discuss in pairs and complete the following sentences with will/would, can/could/could not.

Even Concorde ----- fly as fast as Falcon HTV-2. The news report says: the US Defense Agency ----- launch the Falcon Hypersonic Technology Vehicle-2 into space. Scientists expect that the Falcon HTV-2 ----- fly at 13,000 miles per hour. The US military wishes that the Falcon ----- bomb any part of the world in less than an hour in the future. Engineers plan that they ----- set the Falcon on the back of a rocket to launch it into the distant space.

- F** **Have you ever dreamt of flying to a city/country of your choice? If yes, write about your dream. If not, try to imagine you are flying to that place in a plane. Write about your experience and expectations.**

If you fly westward in a supersonic plane such as Concorde, you will land several hours before you took off. Can you explain how?

**Lesson 6 : Paper has advanced our life**

**Key words :** record paper surface of stone bark encyclopedia wood plunk digital

**A Look at the picture and say what this is. Discuss with your partner.**



**B Read the text and answer the following questions.**

Communication of ideas is at the centre of civilisation. It needs written records. Most of our records in the modern age are on paper. Though writing was invented very early, paper is a more modern invention.

For long in history, people exchanged ideas through speaking and listening. Then there came the art of writing. But to record thoughts in writing was difficult. Writing materials were not available. People used the surface of stone, metal, wood, bark, leaves, etc. for writing. Those things were not easy to carry. Then for ages, people looked for easy writing materials. Finally, Paper was invented in China in 105 AD.

Before the paper age, knowledge was very restricted. Can you think of that time? There were very few books in the world. Maybe, they were written on stone or on heavy wood plunks or on metal sheets. Suppose, one page was a heavy stone block. So think of a hundred-page book! In our age, you can carry the entire world of knowledge in digital form in your laptop bag. You can even carry a huge volume of paper encyclopedia. But who could produce and carry tons of heavy stone books and documents in those paperless days? In fact, paper has made publication and the spread of knowledge and information easy. So you can see how paper has changed our life.

**Questions:**

- 1 How did people exchange ideas before writing was invented?
- 2 Why did people look for easy writing materials?
- 3 Why was knowledge very restricted in the pre-paper age?
- 4 Do you think paper has changed our life? Explain why your answer is 'yes' or 'no'.
- 5 Where was paper invented and when?

**C Discuss with your partner and make a list of things other than paper on which we can write in pens, pencils, markers, brushes, paint/pastels etc.**

**D Listen to the teacher/CD carefully and complete the following sentences.**

**U9, L6 D**

**Listening text: 12**

- 1 The person who invented paper is a ----- man.
- 2 He took the bark of a mulberry tree and ----- fibres.
- 3 This knowledge of ----- was first used in China.
- 4 The word 'paper' is not ----- .
- 5 The word 'paper' was derived from a kind of Egyptian plant called -----

**E Look at the following boxes first. Listen to the teacher/CD again. Then write in the boxes the series of works Ts'ai Lun' did in making paper. First one and the last one are done for you.**

1. He took the bark of mulberry tree and bamboo fibre.

2. He mixed them .....

3. He pounded .....

4. He poured the mixture .....

5. He let the water..... .

6. He let the thing dry.

**F PROJECT WORK:** On a weekend, observe how *ruti* or *paratah* is made in the kitchen. Carefully take notes of each step taken to make it. Then back in class, share your notes with your partner/group. Finally write how *ruti* or *paratah* is made and make a presentation in the class.

### Lesson 7: Contemplation

**A Look at the picture and discuss in groups these questions:**

- 1 Why is the boy up in the tree?
- 2 What is he looking at?
- 3 Guess what he is thinking about.

**B Read the poem and answer the above questions.**

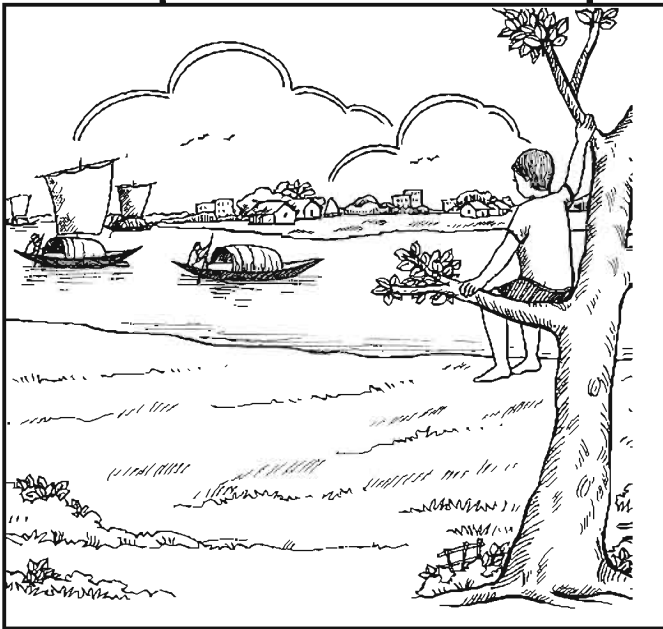

### Contemplation

For days and days I've climbed a tree  
A dappled yellow tree  
And gazed abroad at many things  
I've always wished to see.



I see the green and gentle fields  
All bounded in with hedge  
And shining rivers swimming through  
The rushes on the edge,  
And little sheep who play all day  
I watch them as they run,  
While far away the roofs of town  
Are shining in the sun.

I think it's very nice to sit  
So high and look so far----  
How very large the world can be!  
How many things there are!

*John Carpenter*

### Note

**dappled yellow tree** - spotted yellow tree (the leaves may be yellow)

**gazed abroad** - looked around

**bounded** - surrounded

**hedge** - a thick row of bushes

**swimming through** - (the river like a person is swimming through) flowing through

**rushes** - tall plants that grow on the river's edge

### C Ask and answer these questions.

- 1 Where do you think the tree was?
- 2 What were the four things the poet could see from the tree?
- 3 Have you ever climbed a tree? If yes, what did you do it for? If not, why?

**Sample question for JSC examination****Full marks: 100****Time: 3 hours****Marks for individual items are mentioned next to the test items.****A: Seen part****Read the text and answer questions 1 and 2.**

Bangladeshi cuisine is rich and varied with the use of many spices. We have delicious and appetizing food, snacks and sweets.

Boiled rice is our staple food. It is served with a variety of vegetables, curry, lentil soup, fish and meat. Fish is our main source of protein. Fishes are now cultivated in ponds. Also we have fresh-water fishes in the lakes and rivers. More than 40 types of fishes are common. Some of them are *carp*, *ru*, *katla*, *magur* (catfish), *chingri* (prawn or shrimp). *Shutki* or dried fishes are popular. *Hilsha* is very popular among the people of Bangladesh.

*Panta-ilish* is a traditional platter of *Panta bhat*. It is steamed rice soaked in water and served with a fried *hilsha* slice, often together with dried fish, pickles, lentil soup, green chilies and onion. It is a popular dish on the *Pohela Boishakh*.

The people of Bangladesh are very fond of sweets. Almost all Bangladeshi women prepare some traditional sweets. *Pitha*, a type of sweets made from rice flour, sugar, syrup, molasses and sometimes milk, is a traditional food loved by the entire population. During winter *Pitha Utsab*, meaning *pitha* festival, is organized by different groups of people.

Sweets are distributed among close relatives when there is good news like births, weddings, promotions, etc.

Sweets of Bangladesh are mostly milk-based. The common ones are *roshgolla*, *sandesh*, *rasamalai*, *gulap jamun* and *cham-cham*. There are hundreds of different varieties of sweet preparations. Sweets are therefore an important part of the day-to-day life of Bangladeshi people.

**1. Choose the correct answer to each question from the alternatives given and write the corresponding number of the answers in your answer script.**  
**1x7=7**

- i) The word 'cuisine' in line 1 of the text means-
- a) a style of cooking
  - b) a special kind of food
  - c) cooking spicy dishes
  - d) a combination of different dishes
- ii) The words 'appetizing food' in line 1 of the text mean-
- a) expensive food
  - b) food that makes you feel hungry
  - c) food that is cooked with spices
  - d) food that has good nutritional value
- iii) The word 'platter' in line 8 of the text means-
- a) a large plate to serve food
  - b) a meal served on a large plate
  - c) a dish with a variety of food items on it
  - d) all of the above
- iv) The main source of protein for Bangladeshi people is-
- a) boiled rice
  - b) lentil soup
  - c) fish
  - d) meat
- v) *Panta bhat* is usually served with-
- a) dried fish
  - b) green chili and onion
  - c) hilsha
  - d) all of the above
- vi) *Panta-ilish* is eaten with much festivity
- a) throughout the year

- b) to the wedding guests
- c) on a special day
- d) in winter
- vii) A popular food item in winter is
  - a) lentil soup
  - b) *pitha*
  - c) *panta bhat*
  - d) dried fish

**Answers:** i) a, ii) b, iii) d, iv) c, v) d, vi) c, vii) b

**2. Answer the following questions from your reading of the above text.**

**2x4 = 8**

- a) Name four fresh water fishes.
- b) How is *panta bhat* prepared?
- c) Name four milk-based sweets.
- d) Where are most of the fish cultivated?

**3. Read the following text and fill in the gaps with appropriate words to make it a meaningful one.**

**1x5 = 5**

In a plane, oxygen and the air pressure are always being monitored. In the event of a lack of oxygen, an oxygen mask will automatically (a) \_\_\_\_\_ in front of you. Pull the mask towards you and (b) \_\_\_\_\_ it firmly over your nose and mouth. Secure the elastic band behind your head, and breathe normally. If you are travelling with a child or someone who requires (c) \_\_\_\_\_, secure your mask on first, and then help the other person. Keep your mask on until a uniformed crew member advises you to (d) \_\_\_\_\_ it. In the event of an (e) \_\_\_\_\_ please assume the bracing position.

**Answers:** (a) appear (b) place/put (c) assistance/help/support (d)remove (e) emergency

**B: Unseen part**

**Read the following text and answer questions 4 and 5.**

Meera is a singer with a great zeal for folk songs. She is a dancer too. She enjoys dancing with folk songs. She performs at national events and also represents our culture in different countries. Besides singing she also studies Computer Science in a university in China. Manosh and Rudro are also two promising folk singers of our time. Manosh passed the S.S.C examination in 2018 when Rudro was a student of class eight. Manosh won the Star Voice Singing competition in 2012 in the folk song category. Rudro won that award in 2015 in the same category. He performed in the Boishakhi open concert at Dhaka University campus in 2016. Both Manosh and Rudro love folk songs because it appeals to our root culture. They believe that folk music can reach the heart of our common people easily. In 2018 Manosh successfully released his first album titled 'Mon Janala'.

**4. Complete the table below. Write no more than three words and/or numbers for each answer.**

**1X5=5**

Who?	What?	When/where?
Meera	studies Computer Science	in a university in (1) .....
Meera	(2) .....	in foreign countries
(3) ..... ...	was awarded Star Voice Singing competition	in 2012
Rudro	appeared in the Boisakhi concert	at (4) ..... in 2016
Manos	released his maiden album	(5) ..... in ..... ...

**Answers:** (1) China (2) represents our culture (3) Manosh (4) Dhaka University campus (5) 2018

**5. Read the passage again and write, whether the statements are true or false. Give correct answers, if the statement is false.**

**1x5=5**

- a) Meera enjoys singing folk songs.
- b) Meera performs at both national and international levels.
- c) Manosh and Rudro won two different awards.
- d) The first album of Manosh was released in the same year when he passed the S.S.C. examination.
- e) The common people of our country love folk songs.

**Answers**

- a) False. Meera enjoys dancing with folk songs.
- b) True
- c) False. Manosh and Rudro won the same award.
- d) True
- e) True

**6. Read the text below and fill-in the gaps using the clues given in the boxes. There are more words than necessary. One word can be used once only.**

**½ X10=5**

the	off	as	namely	this	finances
length	cost	country	width	roads	touch

The Padma Multipurpose Bridge is a mega project in the construction history of Bangladesh. This will connect three districts (a) \_\_\_\_\_, Munshiganj, Shariatpur and Madaripur. With (b) \_\_\_\_\_ connectivity 21 districts of (c) \_\_\_\_\_ southwestern part of the (d) \_\_\_\_\_ will come under direct (e) \_\_\_\_\_ with the capital as well (f) \_\_\_\_\_ the whole country. It's total (g) \_\_\_\_\_ is 6.15 kms. and (h) \_\_\_\_\_ is 18.1 meters. It will (i) \_\_\_\_\_ 3.6 billion USD. Bangladesh government (j) \_\_\_\_\_ this huge project.

**Answers:** (a) namely (b) this (c) the (d) country (e) touch (f) as (g) length (h) width (i) cost (j) finances

**7. Read the text below and fill in the gaps using suitable words to make it a meaningful text.**

**1x5=5**

The sun is the source of all energies. All the living beings (a) \_\_\_\_\_ sunlight directly or indirectly for their (b) \_\_\_\_\_ on this earth. Sunlight (c) \_\_\_\_\_ white as we see it with our naked eyes but the actual (d) \_\_\_\_\_ of sunlight is green. Now, we are going to explain why sunlight looks white (e) \_\_\_\_\_ it is originally green.

**Answers:** (a) use (b) existence (c) looks (d) colour (e) though

**8. Match the part of sentences from columns A and B to make five complete sentences. 1x5=5**

Column A	Column B
a. One day a fisherman	i. to see the coins as the fisherman returned home
b. Suddenly he saw	ii. began to boast of it before all the friends
c. His wife was very happy	iii. a bag full of gold coins in his net
d. The fisherman asked his wife to keep	iv. cast his net in the river
e. But instead of doing so she	v. the find of gold coins a secret

**Answers:** a. iv, b. iii, c. i, d. v, e. ii

**C: Grammar part**

**9. Read the text below and fill in the gaps with the root words in the brackets adding suitable suffix, prefix or both.**

$\frac{1}{2} \times 10 = 5$

Altaf Mahmud is a musician, (a) \_\_\_\_\_ (culture) activist and a (b) \_\_\_\_\_ (free) fighter of Bangladesh. He took part in the historic Language (c) \_\_\_\_\_ (move) of 1952. He is the (d) \_\_\_\_\_ (compose) of the famous song “Amar Bhaier Rokte Rangano”. He wrote that immortal song to honour the language martyrs of 1952. The songs composed and sung by Altaf Mahmud were great source of (e) (inspire) to the people who protested against the (f) \_\_\_\_\_ (brutal) of Pakistani Government. Altaf Mahmud was very (g) \_\_\_\_\_ (support) to those who fought for Bangladesh in the Liberation of 1971. He created a camp inside his house to provide (h) \_\_\_\_\_ (accommodate) to them. His (i) \_\_\_\_\_ (patriot) songs were then broadcast from Swadhin Bangla Betar Kendro. He was awarded the Ekushey Padak for his (j) \_\_\_\_\_ (contribute) to Bengali culture and the War of Liberation.

**Answers:** (a) cultural (b) freedom (c) movement (d) composer (e) inspiration (f) brutality (g) supportive (h) accommodation (i) patriotic (j) contribution

**10. Fill-in the gaps in the following text with appropriate articles (a, an or the). Put a cross (x) where no article is used.**

$\frac{1}{2} \times 10 = 5$

Friendship is one of (a) \_\_\_\_\_ most precious gifts of life. (b) \_\_\_\_\_ person who has true friends in life is lucky enough. Friendship makes (c) \_\_\_\_\_ life thrilling. It is indeed, (d) \_\_\_\_\_ asset in life. True friendship is (e) \_\_\_\_\_ feeling of love, sharing and caring. (f) \_\_\_\_\_ true friends stand by us when we are in trouble. Lasting friendship is indeed, (g) \_\_\_\_\_ blessing. However, it is better to have friends of (h) \_\_\_\_\_ same age group and mentality. In short, friendship is (i) \_\_\_\_\_ essential condition for (j) \_\_\_\_\_ happy life.

**Answers:** (a) the (b) a (c) x (d) an (e) a (f) x (g) a (h) the (i) an (j) a



**11. Change the following sentences as directed in the brackets.****1x5= 5**

(a) Sylhet is one of the most beautiful districts of Bangladesh. (Make it a comparative sentence). (b) In the 14<sup>th</sup> century, Saint Hazrat Shah Jalal conquered Sylhet. (Make it a passive sentence). (c) It was declared as a division by the government in 1995. (Make it an active sentence). (d) The vast green tea gardens attract many tourists. (Make it an interrogative sentence). (e) The climate of this place is very fine. (Make it an exclamatory sentence).

**Answer:** (a) Sylhet is more beautiful than most other districts of Bangladesh. (b) Sylhet was conquered by Saint Hazrat Shah Jalal in the 14<sup>th</sup> century. (c) The government declared it as a division in 1995. (d) Do the vast green tea gardens attract many tourists? (e) How fine the climate of this place is!

**12. Rewrite the following passage changing the form of speech:****5**

“It’s so unusual! It’s a cold night, but I feel warm now,” the Prince said. “It happens when I do something good to help someone,” he added. The Queen smiled to look at his son and said “Good night” “Good night” The Prince also smiled and said to his mom.

**Answer:** The Prince wondered at the unusual feature of the night because he felt warm even at that time of the cold night. He remarked that it (unusual behavior of the night) happens when he does something good to help someone. The Queen smiled to look at his son and wished him good night. The Prince also smiled at her mom as he said her good night.

**13. Use capital letters and punctuation marks as needed in the following passage.****½ X10=5**

one day Neela went to see bela her elder sister bela she found her very depressed there Neela asked what happens darling

**Answer:** One day Neela went to see Bela, her elder sister. She found her very depressed there. Neela asked, “What happens, darling? “

## D: Writing part

**14. Suppose you are Rabid and you are in a restaurant with your sister. Make a dialogue between you and the waiter before ordering your meal.**

**10**

**Answer (sample only):**

Waiter	Can I help you?
Rabid	A table for two please.
Waiter	You can take this table, sir.
Rabid	Thanks, this is a nice corner table.
Waiter	Are you ready to order?
Rabid	Yes, we'll have the cashew nut salad, a Thai soup and a serve of fried rice with chili chicken.
Waiter	Anything to drink?
Rabid	Just water for me and a lemonade for my sister, please.
Waiter	Is that all, sir?
Rabid	Yes, I think, that's all for now. Thank You.

**15. A social organisation in your locality is hiring some volunteers for a fund raising event. Write an email to the coordinator of that organisation to be a volunteer for the event. The email can be sent to abcd123@charity.org.bd. In your email, you should**

**10**

- write a subject line
- use proper salutation/greetings
- give a brief introduction of you
- express your interest for the role of a volunteer
- mention why you are interested to work as a volunteer
- write a closing remark, your name, address and phone

**Sample answer**

To: abcd123@charity.org.bd

Subject: Interested to be a volunteer

Dear sir/madam,

I am a student of class eight at ABC Boys High School, Pabna. I have seen your advertisement about hiring volunteers for your charity event. I am really interested to work as a volunteer for that event.

I always look for opportunities to help the poor and helpless people in our society. Moreover, I enjoy working with like-minded people in a team.

I hope to hear from you soon.

Thanking you,

Mohamad Zaif  
123, ..... Road, Pabna

**16. Write a paragraph of 250 words on the advantages and disadvantages of nuclear families. Your writing should address the following questions:**

**10**

- What is a nuclear family?
- What are the advantages of a nuclear family?
- What are the disadvantages of a nuclear family?
- What kind of family do you prefer, why?

-----o-----

**Sample question for JSC examination****Full marks: 100****Time: 3 hours****Marks for individual items are mentioned next to the test items.****A: Seen part****Read the text and answer questions 1 and 2.**

Good afternoon passengers. This is your captain Rashid Akbar speaking. First I'd like to welcome everyone on Flight BG 88. We are currently cruising at an altitude of 10058.40 feet at airspeed of 643.7376 km per hour. The time is 1:25 pm. The weather looks good and with the tailwind on our side we are expecting to land in Bangkok approximately fifteen minutes ahead of schedule. The weather in Bangkok is clear and sunny. The temperature is 32 degrees Celsius for this afternoon. If the weather is good, we should get a great view of the city as we descend. The cabin crew will be coming around in about twenty minute's time to offer you a light snack and drinks. The inflight movie will begin shortly after that. I'll talk to you again before we reach our destination. Until then, sit back, and enjoy the flight.

**1. Now choose the correct answer to each question from the alternatives given and write the corresponding number of the answers in your answer script.**

**1x7=7**

i) What is the job of Rashid Akbar?

- a) Cabin Crew
- b) Announcer
- c) Pilot
- d) An army officer

ii) The word cruise means-

- a) moving ahead
- b) moving fast
- c) travelling at a steady speed
- d) None of the above

iii) The word "tailwind" means-

- a) wind blowing from behind a moving vehicle
- b) wind coming from front
- c) the wind that blows around the tail
- d) the wind that propels the tail

iv) What is the objective of the announcer?

- a) to call everyone's attention
- b) to warn the passengers
- c) to begin a communication
- d) to give necessary information

v) When can the passengers get the view of the city?

- a) within fifteen minutes
- b) as the flight comes down
- c) all through the flight in the sky
- d) immediately after the announcement

vi) Passengers will be treated with some light refreshment within

- a) 15 minutes
- b) 20 minutes
- c) 25 minutes
- d) 32 minutes

vii) Where is the temperature 32 degree Celsius?

- a) inside the plane
- b) outside the plane
- c) Bangkok
- d) In departure city

### Answers

i) c    ii) a    iii) a    iv) d    v) b    vi) b    vii) c

**2. Answer the following questions from your reading of the text above.**

**2x 4 = 8**

- a) Where is the flight now?
- b) What destination is the flight bound for?
- c) When will the in-flight movie begin?
- d) Why did the announcer describe the weather?

**3. Read the following text and fill in the gaps with contextually appropriate words 1X5=5**

River gypsies are an ethnic group of people in Bangladesh. They are known as *beday* to (a) \_\_\_\_\_ people. The (b) \_\_\_\_\_ have their own lifestyle and (c) ..... They live in groups and do not (d) \_\_\_\_\_ any land. Therefore, they live a nomadic life, (e) \_\_\_\_\_ from one place to another.

**Answers:** (a) local (b) gypsies (c) culture (d) own/have  
(d)travelling/moving/roaming/shifting (e) roam/move/travel

### **B: Unseen part**

**Read the following text and answer questions 4 and 5.**

The current world population roughly calculated by the United Nations is 7.5 billion as of September 2017. Six of the seven continents of the Earth are permanently resided on a large scale. Asia is the most populous continent, with its 4.54 billion inhabitants accounting for 60% of the world population. China and India are world's most populated countries. They together have about 37% of the world's population. Africa is the second most populated continent, with around 1.28 billion people and it is 16% of the world's population. The population of Europe is 742 million which is 10% of the world's population as of 2018, while 651 million live in the Latin America and Caribbean regions and it is 9% of the world's population. Northern America primarily consisting of the United States and Canada has a population of around 363 million which is 5% and Oceania is the least-populated region with about 41 million inhabitants which is 0.5% of world population although it is not permanently resided by any fixed population. Antarctica has also a small and varied international population based mainly in polar science station.

**4. Complete the grid below with appropriate information.**

**1X5=5**

Continent/ Country	Population	% of world population
Asia	4.5 billion	i)..... ....
Africa	ii).....	16%
iii) ..... ....	742 million	10%
U.S.A and Canada	iv)..... ....	5%
Oceania	41 million	v)..... ..

**Answers:** i) 60%    ii) 1.28 billion    iii) Europe    iv) 363 million    v) 0.5%

**5. Read the passage again and write, whether the statements are true or false. Give correct answers, if the statement is false.**

**1x5=5**

- Asia has the largest population among all the seven continents.
- Africa is in the third position in case of the number of population.
- The number of population in Europe is the same as in Asia.
- The United States and Canada are the North American countries.
- In Oceania and Antarctica, the number of population rises and falls.

**Answers**

- True
- False. Africa is in the second position in case of the number of population.
- False The number of population in Europe is less than that of Asia.
- True
- True

**6. Read the text below and fill in the gaps using clues from the boxes. There are more words than necessary.**

$\frac{1}{2} \times 10 = 5$

connectivity	remains	cannot	without	among	
Pandora	for	education	strange	made	dimension

Mobile phone is a wonderful invention of modern science. It has added a new (a) \_\_\_\_\_ to our everyday life. People (b) \_\_\_\_\_ think of a single moment (c) \_\_\_\_\_ a mobile phone. It has (d) \_\_\_\_\_ life easier by increasing our (e) \_\_\_\_\_. No doubt the world now (f) \_\_\_\_\_ in our pocket through this (g) \_\_\_\_\_ device. It is really a (h) \_\_\_\_\_ box which can be used (i) \_\_\_\_\_ different purposes like entertainment to (j) \_\_\_\_\_.

**Answers**

(a) dimension (b) cannot (c) without (d) made (e) connectivity (f) remains (g) strange (h) Pandora (i) for (j) education

**7. Read the text below and fill in the gaps with words that are appropriate.**

$1 \times 5 = 5$

The world is changing every day. People are constantly moving to different (a) \_\_\_\_\_ for different reasons. So people need (b) \_\_\_\_\_ journey. People also need speed. Wheels (c) \_\_\_\_\_ made it possible. This is why, (d) \_\_\_\_\_ of wheels is so important to (e) \_\_\_\_\_.

**Answers**

(a) destinations (b) comfortable (c) have (d) invention (e) us.



**8. Match the part of sentences from columns A and B to make five complete sentences. Column B has one more options than required.**

**1x5=5**

Column A	Column B
a. Once upon a time there was a king	i. went everywhere on foot.
b. He was extremely	ii. to invent some kind of seat that could move by itself.
c. Being afraid of riding horse he	iii. who was known as Prudence.
d. Naturally, his soldiers and ministers	iv. cautious and very nervous as well.
e. At last, they went to a magician and requested him	v. had to walk on foot too.
	vi. To go home.

**Answers**

a. iii b. iv c. i d. v e. ii

**C: Grammar part**

**9. Read the text below and fill in the gaps with the root words in the brackets adding suitable suffix, prefix or both.**

**½ x10=5**

Visa, the global payment solutions (a) \_\_\_\_\_ (provide) will introduce (b) \_\_\_\_\_ (contact)\_cards in Bangladesh this year. These cards do not have (c) \_\_\_\_\_ (paid) system and allow customers to make (d) \_\_\_\_\_ (pay) simply by waving the card near the point of sales machine. It needs no (e) \_\_\_\_\_ (insert) of the card into the machine. The cards provide customers with improved and (f) \_\_\_\_\_ (speed) transaction. It will be (g) \_\_\_\_\_ (fast) and offer increased protection from card fraud than (h) \_\_\_\_\_ (tradition) cards. Such payment solution will add (i) \_\_\_\_\_ (secure) to card service (j) \_\_\_\_\_ (significant).

**Answers:**

a) provider b) contactless c) prepaid d) payment e) insertion  
f) speedy g) faster h) traditional i) security j) significantly

**10. Fill in the gaps of the following text with appropriate articles (a, an or the). Put a cross (x) for zero article.**

$\frac{1}{2} \times 10 = 5$

(a)\_\_\_\_\_ violent storm hit Netrokona district last week. The storm blew at (b)\_\_\_\_\_ speed of 150 km per hour. It hit 12 villages and demolished almost all (c)\_\_\_\_\_ houses of those villages. It caused (d)\_\_\_\_\_ severe damage. All (e)\_\_\_\_\_ the electric poles were blew up and as a result there was a power-cut. People had to remain in darkness for over (f)\_\_\_\_\_ week. It was (g)\_\_\_\_\_ unbearable situation for them. (h)\_\_\_\_\_ poor suffered (i)\_\_\_\_\_ lot. It was really (j)\_\_\_\_\_ terrible storm.

**Answers:** (a) a (b) a (c) the (d) x (e) the (f) a (g) an (h) the (i) a (j) a

**11. Change the following sentences as directed in the brackets.**

$1 \times 5 = 5$

(a) Dhaka was founded by the Mughals in the 17<sup>th</sup> century. (Make it an active sentence).  
 (b) The Mughals governed the region during the early modern period. (Make it an interrogative sentence).  
 (c) The Mughals constructed many buildings here. (Make it a passive sentence).  
 (d) Ahsan Manjil is one of the attractive buildings. (Make it an exclamatory sentence).  
 (e) Nila is yet to visit Dhaka (make it a negative sentence in terms of sentence construction).

**Answer:** (a) The Mughals founded it in the 17<sup>th</sup> century. (b) Did the Mughals govern the region during the early modern period? (c) Many buildings were constructed here by the Mughals. (d) What an attractive building the Ahsan Manjil is! (e) Nila did not visit Dhaka yet.

**12. Rewrite the following passage changing the form of speech:**

5

Sakina said to Himel, "How are you? I went to your house yesterday but you were not there." "I went to a shop," said Himel, "I had to buy some dresses for my sister."

**Answer:** Sakina asked Himel how he was. She told him that she had gone to his house the previous day but he was not there. Himel replied that he had gone to a shop and added that he had to buy some dresses for his sister.

**13. Use capital letters and punctuation marks as needed in the following passage.  
.5X10=5**

daniel defoe the writer of robinson crusoe was born in london in 1660 defoe started to write when he was a young man the idea for writing the great story came from the story of alexander selkirk when he was at the age of 59

**Answer:** Daniel Defoe, the writer of Robinson Crusoe was born in London in 1660. Defoe started to write when he was a young man. The idea for writing the great story came from the story of Alexander Selkirk when he was at the age of 59.

#### **D: Writing part**

**14. Suppose you are Samiya and chatting with your cousin, Subarno. Make a dialogue with him/her about folk songs.**

**10**

**Key (This is just an example.)**

Samiya	Ah, you are listening to music!
Subarno	Oh, yes. You know Samiya, I'm so fond of music.
Samiya	I know. But I'm not sure what type of music you like.
Subarno	To be honest, I like Bangla folk music.
Samiya	Great. Please tell me about the folk songs. I know little about it.
Subarno	Ok, the folk songs are the traditional songs of Bangladesh. It is sung by the common people of the country. It is simple in terms of theme, tunes, lyric or melody. Polligiti, bhatiyali, lolongiti are some of our popular folk songs.
Samiya	Can you tell me about some famous folk singers?
Subarno	Sure, Hason Raja, Abbasuddin, Abdul Alim, or recent Momtaj Begum, Firoj Shai, Dilruba Khan are some famous folk singers. You must listen to them.
Samiya	Ok. I'll.

**15. You have invited some of your friends to a get together at your place. Unfortunately, you are unable to hold the event as you have fallen sick. Write an email to one of your invited friends telling that the event is postponed now. You may send the email to [abcd123@gmail.com](mailto:abcd123@gmail.com). In your email, you should**

**10**

- write a subject line
- use proper salutation/greetings
- tell that the event is postponed
- give reasons for the postponement
- regret for the unfortunate situation
- write a closing remark
- write your name

**Sample answer**

To: [abcd123@gmail.com](mailto:abcd123@gmail.com)

Subject: Get together postponed

Hello X,

Hope you are doing well. I am passing horrible time as I have been fighting a nasty viral flu since last week. That means we are not going to get together this weekend. I am extremely sorry for cancelling the event.

I hope you will understand my situation. We may think about a new date when I come round.

Please pray for my recovery.

Best regards,

Y

**16. Write a paragraph on your favourite movie/TV programme. You have to write what the movie/programme is about, why you like it, and what your learning is from this movie/programme.**

**End**

# 2020

## Academic Year

### 8-English

শিক্ষাই দেশকে দারিদ্র্যমুক্ত করতে পারে  
— মাননীয় প্রধানমন্ত্রী শেখ হাসিনা

**Necessity is the mother of invention**

তথ্য, সেবা ও সামাজিক সমস্যা প্রতিকারের জন্য '৩৩৩' কলসেন্টারে ফোন করুন

নারী ও শিশু নির্যাতনের ঘটনা ঘটলে প্রতিকার ও প্রতিরোধের জন্য ন্যাশনাল হেল্পলাইন সেন্টারে  
১০৯ নম্বর-এ (টোল ফ্রি, ২৪ ঘণ্টা সার্ভিস) ফোন করুন



**Ministry of Education**

For free distribution from academic year 2010 by the Government of the  
People's Republic of Bangladesh